

SPIEGEL ADAPTER FÜR MODELLE MIT LENKERAUFNAHME / SCOOTER

Marke	Modelle	Jahr	DRIFT BS400	ONE BS250 / BS251	VELOCE NAKED BS206	VELOCE L NAKED BS306
Universal	Alle	Alle	BS411A	—	BS711A	BS711A
Universal	Alle	Alle	BS411B	BS811B	BS711B	BS711B
Ausser						
BMW®	C 600 SPORT / C 650 GT	12 -	—	—	—	—
BMW®	F 800 R	09 - 14	BS411	BS812	BS711	BS711
BMW®	F 800 GS ADVENTURE	13 -	BS813 + BS411 / BS487 ¹	BS813	BS813 + BS711 / BS787 ¹	BS813 + BS711 / BS787 ¹
BMW®	HP2 MEGAMOTO	07 -	BS411	BS812	BS711	BS711
BMW®	K 1200 R	05 - 08	BS411	BS812	BS711	BS711
BMW®	K 1200 RS	97 - 06	—	—	BS714	BS714
BMW®	K 1300 R	09 - 11	BS411	BS812	BS711	BS711
BMW®	R 1150 R / R 1150 RS	00 - 07	—	—	BS714	BS714
BMW®	R 1150 GS	99 - 06	—	—	BS714	BS714
BMW®	R 1200 GS	04 - 12	BS487	BS812	BS711 / BS787 ¹	BS711 / BS787 ¹
BMW®	R 1200 GS	13 -	BS487	BS813	BS711 / BS787 ¹	BS711 / BS787 ¹
BMW®	R 1200 GS ADVENTURE	14 -	BS487	BS813	BS787	BS787
BMW®	R 1200 GS ADVENTURE	10 - 13	BS487	BS812	BS787	BS787
BMW®	R 1200 R / R CLASSIC	06 - 15	BS411	BS812	BS711	BS711
BMW®	R 1200 RS	16 -	—	—	BS759	BS759
BMW®	R nineT	14 -	BS411 / BS487 ¹	BS812	BS711 / BS787 ¹	BS711 / BS787 ¹
BMW®	R nineT Scrambler	16 -	BS411 / BS487 ¹	BS812	BS711 / BS787 ¹	BS711 / BS787 ¹
BMW®	S 1000 R	14 -	BS411 / BS487 ¹	BS812	BS711 / BS787 ¹	BS711 / BS787 ¹
BMW®	S 1000 XR	15 -	BS411 / BS487 ¹	BS812	BS711 / BS787 ¹	BS711 / BS787 ¹
DUCATI®	DIAVEL	10 -	BS487	BS815	BS787	BS787
DUCATI®	XDIAVEL S	16 -	BS487	BS815	BS787	BS787
DUCATI®	MONSTER 696	08 -	—	BS815	BS715	BS715
DUCATI®	MONSTER 796	10 -	—	BS815	BS715	BS715
DUCATI®	MONSTER 821	14 -	BS487	BS815	BS715 / BS787 ¹	BS715 / BS787 ¹
DUCATI®	MONSTER 1100 / 1100 EVO	09 -	—	BS815	BS715	BS715
DUCATI®	MONSTER 1200	14 -	—	BS815	BS715	BS715
DUCATI®	MULTISTRADA 1200 / 1200 S	15 -	—	—	BS736	BS736
DUCATI®	MULTISTRADA 1200 / 1200 S	10 - 14	—	—	BS716 / BS717 ²	BS716 / BS717 ²
DUCATI®	STREETFIGHTER 848	13 -	—	BS815	BS715	BS715
DUCATI®	STREETFIGHTER	09 -	—	BS815	BS715	BS715
HARLEY-DAVIDSON®	Alle	Alle	BS414	Inklusiv ³	BS714	BS714
HONDA®	AFRICA TWIN	16 -	BS487	BS811	BS711 / BS787 ¹	BS711 / BS787 ¹
HONDA®	CB 500 F	16 -	BS487	BS811	BS711 / BS787 ¹	BS711 / BS787 ¹
HONDA®	CB 650 F	15 -	BS411	BS811	BS711 / BS787 ¹	BS711 / BS787 ¹
HONDA®	CB 1000 R	13 -	BS487	BS811	BS711 / BS787 ¹	BS711 / BS787 ¹
HONDA®	INTEGRA	12 -	BS487	BS811	BS711 / BS787 ¹	BS711 / BS787 ¹
HONDA®	NC700X	12 -	BS487	BS811	BS711 / BS787 ¹	BS711 / BS787 ¹
KAWASAKI®	ER-6N	12 -	BS487	BS811	BS711 / BS787 ¹	BS711 / BS787 ¹
KAWASAKI®	VERSYS 1000 ABS	12 -	BS487	BS811	BS711 / BS787 ¹	BS711 / BS787 ¹
KAWASAKI®	Z300	15 -	BS411	BS811	BS711 / BS787 ¹	BS711 / BS787 ¹
KAWASAKI®	Z750R	11 -	BS487	BS811	BS787	BS787
KAWASAKI®	Z800	13 -	BS487	BS811	BS787	BS787
KAWASAKI®	Z1000	10 - 13	BS487	BS811	BS787	BS787
KAWASAKI®	Z1000	14 -	BS487	BS811	BS787	BS787
KTM®	125 DUKE	15 -	BS411	BS811	BS711 / BS787 ¹	BS711 / BS787 ¹
KTM®	390 DUKE	15 -	BS411	BS811	BS711 / BS787 ¹	BS711 / BS787 ¹
MV AGUSTA®	BRUTALE 675	12 -	BS411	BS811	BS711	BS711
MV AGUSTA®	BRUTALE 800 / 1090	13 - 15	BS411	BS811	BS711	BS711
MV AGUSTA®	BRUTALE (Andere Modelle)	Alle	—	—	BS730	BS730
MV AGUSTA®	RIVALE 800 EAS	13 -	BS871 + BS411 / BS487 ^{2/1} BS870 + BS411 / BS487 ^{2/1}	BS871 ² BS870 ²	BS871 ² BS870 ²	BS871 ² BS870 ²
SUZUKI®	GSF 600 BANDIT	00 - 05	BS487	BS811	BS787	BS787
SUZUKI®	GSF 1200 BANDIT	01 - 06	BS487	BS811	BS787	BS787
SUZUKI®	GSX-S 1000	15 -	BS411/BS487 ¹	BS811	BS711/BS787 ¹	BS711/BS787 ¹
TRIUMPH®	BONNEVILLE T100	08 -	BS414	BS814	BS804	BS804
TRIUMPH®	BONNEVILLE T120	16 -	BS414	BS814	BS804	BS804
TRIUMPH®	SPEED TRIPLE 1050 R	16 -	BS411 + BS770	BS811 + BS770	BS711 + BS770	BS711 + BS770
TRIUMPH®	STREET TRIPLE RX	15 -	BS411	BS811	BS711 / BS787 ¹	BS711 / BS787 ¹
TRIUMPH®	STREET TRIPLE / R	13 -	BS487	BS811	BS711 / BS787 ¹	BS711 / BS787 ¹
TRIUMPH®	STREET TWIN	16 -	—	BS811	BS797	BS797
TRIUMPH®	TIGER 800 / EXPLORER	11 -	BS487	BS811	BS711 / BS787 ¹	BS711 / BS787 ¹
TRIUMPH®	THRUXTON	15 -	BS414	BS814	BS804	BS804
YAMAHA®	XV950R	14 -	BS411/BS487 ¹	BS811	BS711 / BS787 ¹	BS711 / BS787 ¹
YAMAHA®	T-MAX 500	08 - 11	—	—	BS775 / BS786 ⁴	BS775 / BS786 ⁴
YAMAHA®	T-MAX 530	12 -	—	—	BS775 / BS805 ⁴	BS775 / BS805 ⁴

¹ Wahlweise BS787 (h 57,5 mm) oder BS711 / BS715 (h 41,5 mm). Wahlweise BS487 (h 57 mm) oder BS411 (h 39 mm). Wählen Sie den passenden Adapter nach Fahrstil.

² BS716 links, BS717 rechts. BS416 links, BS417 rechts. BS870 links, BS871 rechts. BS870 / BS871 kompatibel mit den Original Handprotektoren montiert werden.

³ Der Artikel BS251 ist nur für HARLEY-DAVIDSON®, die passenden Adapter werden mitgeliefert.

⁴ BS786B / BS805B Spiegel-Adapter für Frontverkleidungen. BS775B Spiegel-Adapter für Lenker. Wir empfehlen die Spiegelbohr Abdeckungen BS522B für T-MAX 500 und BS806A für T-MAX 530.

SPIEGEL ADAPTER FÜR MODELLE MIT LENKERAUFNAHME / SCOOTER

Marke	Modelle	Jahr	4D	RADIAL RS	ELISSE
			BS207 / BS208	BS132	BS171 / BS172
Universal	Alle	Alle	BS711A	BS711A	BS711A
Universal	Alle	Alle	BS711B	BS711B	BS711B
Ausser					
BMW®	C 600 SPORT / C 650 GT	12 -	BS790	BS790	BS790
BMW®	F 800 R	09 - 14	BS711	BS711	BS711
BMW®	F 800 GS ADVENTURE	13 -	BS813 + BS711 / BS787 ¹	BS813 + BS711 / BS787 ¹	BS813 + BS711 / BS787 ¹
BMW®	HP2 MEGAMOTO	07 -	BS711	BS711	BS711
BMW®	K 1200 R	05 - 08	BS711	BS711	BS711
BMW®	K 1200 RS	97 - 06	BS714	BS714	BS714
BMW®	K 1300 R	09 - 11	BS711	BS711	BS711
BMW®	R 1150 R / R 1150 RS	00 - 07	BS714	BS714	BS714
BMW®	R 1150 GS	99 - 06	BS714	BS714	BS714
BMW®	R 1200 GS	13 -	BS711 / BS787 ¹	BS711 / BS787 ¹	BS711 / BS787 ¹
BMW®	R 1200 GS	04 - 12	BS711 / BS787 ¹	BS711 / BS787 ¹	BS711 / BS787 ¹
BMW®	R 1200 GS ADVENTURE	14 -	BS787	BS787	BS787
BMW®	R 1200 GS ADVENTURE	10 - 13	BS787	BS787	BS787
BMW®	R 1200 R / R CLASSIC	06 - 15	BS711	BS711	BS711
BMW®	R 1200 RS	16 -	BS759	BS759	BS759
BMW®	R nineT	14 -	BS711 / BS787 ¹	BS711 / BS787 ¹	BS711 / BS787 ¹
BMW®	R nineT Scrambler	16 -	BS711 / BS787 ¹	BS711 / BS787 ¹	BS711 / BS787 ¹
BMW®	S 1000 R	14 -	BS711 / BS787 ¹	BS711 / BS787 ¹	BS711 / BS787 ¹
BMW®	S 1000 XR	14 -	BS711 / BS787 ¹	BS711 / BS787 ¹	BS711 / BS787 ¹
DUCATI®	DIAVEL	10 -	BS787	BS787	BS787
DUCATI®	XDIAVEL S	16 -	BS787	BS787	BS787
DUCATI®	MONSTER 696	08 -	BS715	BS715	BS715
DUCATI®	MONSTER 796	10 -	BS715	BS715	BS715
DUCATI®	MONSTER 821	14 -	BS715 / BS787 ¹	BS715 / BS787 ¹	BS715 / BS787 ¹
DUCATI®	MONSTER 1100 / 1100 EVO	09 -	BS715	BS715	BS715
DUCATI®	MONSTER 1200	14 -	BS715	BS715	BS715
DUCATI®	MULTISTRADA 1200 / 1200 S	15 -	BS736	BS736	BS736
DUCATI®	MULTISTRADA 1200 / 1200 S	10 - 14	BS716 / BS717 ²	BS716 / BS717 ²	BS716 / BS717 ²
DUCATI®	STREETFIGHTER 848	13 -	BS715	BS715	BS715
DUCATI®	STREETFIGHTER	09 -	BS715	BS715	BS715
HARLEY-DAVIDSON®	Alle	Alle	BS714	BS714	BS714
HONDA®	AFRICA TWIN	16 -	BS711 / BS787 ¹	BS711 / BS787 ¹	BS711 / BS787 ¹
HONDA®	CB 500 F	16 -	BS711 / BS787 ¹	BS711 / BS787 ¹	BS711 / BS787 ¹
HONDA®	CB 650 F	15 -	BS711 / BS787 ¹	BS711 / BS787 ¹	BS711 / BS787 ¹
HONDA®	CB 1000 R	13 -	BS711 / BS787 ¹	BS711 / BS787 ¹	BS711 / BS787 ¹
HONDA®	NC700X	12 -	BS711 / BS787 ¹	BS711 / BS787 ¹	BS711 / BS787 ¹
HONDA®	INTEGRA	12 -	BS711 / BS787 ¹	BS711 / BS787 ¹	BS711 / BS787 ¹
KAWASAKI®	ER-6N	12 -	BS711 / BS787 ¹	BS711 / BS787 ¹	BS711 / BS787 ¹
KAWASAKI®	Z300	15 -	BS711 / BS787 ¹	BS711 / BS787 ¹	BS711 / BS787 ¹
KAWASAKI®	Z750R	11 -	BS711 / BS787 ¹	BS787	BS787
KAWASAKI®	Z800	13 -	BS787	BS787	BS787
KAWASAKI®	Z1000	10 - 13	BS787	BS787	BS787
KAWASAKI®	Z1000	14 -	BS787	BS787	BS787
KAWASAKI®	VERSYS 1000 ABS	12 -	BS787	BS711 / BS787 ¹	BS711 / BS787 ¹
KTM®	125 DUKE	15 -	BS711 / BS787 ¹	BS711 / BS787 ¹	BS711 / BS787 ¹
KTM®	390 DUKE	15 -	BS711 / BS787 ¹	BS711 / BS787 ¹	BS711 / BS787 ¹
MV AGUSTA®	BRUTALE 675	12 -	BS711	BS711	BS711
MV AGUSTA®	BRUTALE 800 / 1090	13 - 15	BS711	BS711	BS711
MV AGUSTA®	BRUTALE (Andere Modelle)	Alle	BS730	BS730	BS730
MV AGUSTA®	RIVALE 800 EAS	13 -	BS871 ² BS870 ²	BS871 ² BS870 ²	BS871 ² BS870 ²
SUZUKI®	GSF 600 BANDIT	00 - 05	BS787	BS787	BS787
SUZUKI®	GSF 1200 BANDIT	01 - 06	BS787	BS787	BS787
SUZUKI®	GSX-S 1000	15 -	BS711/BS787 ¹	BS711 / BS787 ¹	BS711 / BS787 ¹
TRIUMPH®	BONNEVILLE T100	08 -	BS804	BS804	BS804
TRIUMPH®	BONNEVILLE T120	16 -	BS804	BS804	BS804
TRIUMPH®	SPEED TRIPLE 1050 R	16 -	BS711 + BS770	BS711 + BS770	BS711 + BS770
TRIUMPH®	STREET TRIPLE RX	15 -	BS711 / BS787 ¹	BS711 / BS787 ¹	BS711 / BS787 ¹
TRIUMPH®	STREET TRIPLE / R	13 -	BS711 / BS787 ¹	BS711 / BS787 ¹	BS711 / BS787 ¹
TRIUMPH®	STREET TWIN	16 -	BS797	BS797	BS797
TRIUMPH®	TIGER 800 / EXPLORER	11 -	BS711 / BS787 ¹	BS711 / BS787 ¹	BS711 / BS787 ¹
TRIUMPH®	THRUXTON	15 -	BS804	BS804	BS804
YAMAHA®	XV950R	14 -	BS711 / BS787 ¹	BS711 / BS787 ¹	BS711 / BS787 ¹
YAMAHA®	T-MAX 500	08 - 11	BS775 / BS786 ⁴	BS775 / BS786 ⁴	BS775 / BS786 ⁴
YAMAHA®	T-MAX 530	12 - 16	BS775 / BS805 ⁴	BS775 / BS805 ⁴	BS775 / BS805 ⁴

¹ Wahlweise BS787 (h 57,5 mm) oder BS711 / BS715 (h 41,5 mm). Wahlweise BS487 (h 57 mm) oder BS411 (h 39 mm). Wählen Sie den passenden Adapter nach Fahrstil.

² BS716 links, BS717 rechts. BS416 links, BS417 rechts. BS870 links, BS871 rechts. BS870 / BS871 kompatibel mit den Original Handprotektoren montiert werden.

³ Der Artikel BS251 ist nur für HARLEY-DAVIDSON®, die passenden Adapter werden mitgeliefert.

⁴ BS786B / BS805B Spiegel-Adapter für Frontverkleidungen. BS775B Spiegel-Adapter für Lenker: Wir empfehlen die Spiegelbohr Abdeckungen BS522B für T-MAX 500 und BS806A für T-MAX 530.

SPIEGEL ADAPTER FÜR MODELLE MIT LENKERAUFNAHME / SCOOTER

Marke	Modelle	Jahr	DYNAMIC BS180	TOMOK BS160 / BS162	CIRCUIT 959 BS203 / BS204	CIRCUIT 744 BS201 / BS202
Universal	Alle	Alle	BS711A	BS711A	Inklusiv	BS711A
Universal	Alle	Alle	BS711B	BS711B	Inklusiv	BS711B
Ausser						
BMW®	C 600 SPORT / C 650 GT	12 -	—	BS790	—	BS790
BMW®	F 800 R	09 - 14	BS711	BS711	BS714	BS711
BMW®	F 800 GS ADVENTURE	13 -	BS813 + BS711 / BS787 ¹	BS813 + BS711 / BS787 ¹	BS813	BS813 + BS711 / BS787 ¹
BMW®	HP2 MEGAMOTO	07 -	BS711	BS711	BS714	BS711
BMW®	K 1200 R	05 - 08	BS711	BS711	BS714	BS711
BMW®	K 1200 RS	97 - 06	BS714	BS714	BS714	BS714
BMW®	K 1300 R	09 - 11	BS711	BS711	BS714	BS711
BMW®	R 1150 R / R 1150 RS	00 - 07	BS714	BS714	—	BS714
BMW®	R 1150 GS	99 - 06	BS714	BS714	BS714	BS714
BMW®	R 1200 GS	13 -	BS711 / BS787 ¹	BS711 / BS787 ¹	BS714	BS711 / BS787 ¹
BMW®	R 1200 GS	04 - 12	BS711 / BS787 ¹	BS711 / BS787 ¹	BS714	BS711 / BS787 ¹
BMW®	R 1200 GS ADVENTURE	14 -	BS787	BS787	BS714	BS787
BMW®	R 1200 GS ADVENTURE	10 - 13	BS787	BS787	BS714	BS787
BMW®	R 1200 R / R CLASSIC	06 - 15	BS711	BS711	BS714	BS711
BMW®	R 1200 RS	16 -	BS759	BS759	—	BS759
BMW®	R nineT	14 -	BS711 / BS787 ¹	BS711 / BS787 ¹	BS714	BS711 / BS787 ¹
BMW®	R nineT Scrambler	16 -	BS711 / BS787 ¹	BS711 / BS787 ¹	BS714	BS711 / BS787 ¹
BMW®	S 1000 R	14 -	BS711 / BS787 ¹	BS711 / BS787 ¹	BS714	BS711 / BS787 ¹
BMW®	S 1000 XR	15 -	BS711 / BS787 ¹	BS711 / BS787 ¹	BS714	BS711 / BS787 ¹
DUCATI®	DIAVEL	10 -	BS787	BS787	BS780	BS787
DUCATI®	XDIAVEL S	16 -	BS787	BS787	BS780	BS787
DUCATI®	MONSTER 696	08 -	BS715	BS715	BS780	BS715
DUCATI®	MONSTER 796	10 -	BS715	BS715	BS780	BS715
DUCATI®	MONSTER 821	14 -	BS715 / BS787 ¹	BS715 / BS787 ¹	BS780	BS715 / BS787 ¹
DUCATI®	MONSTER 1100 / 1100 EVO	09 -	BS715	BS715	BS780	BS715
DUCATI®	MONSTER 1200	14 -	BS715	BS715	BS780	BS715
DUCATI®	MULTISTRADA 1200 / 1200 S	15 -	BS736	BS736	—	BS736
DUCATI®	MULTISTRADA 1200 / 1200 S	10 - 14	BS716 / BS717 ²	BS716 / BS717 ²	—	BS716 / BS717 ²
DUCATI®	STREETFIGHTER 848	13 -	BS715	BS715	BS780	BS715
DUCATI®	STREETFIGHTER	09 -	BS715	BS715	BS780	BS715
HARLEY-DAVIDSON®	Alle	Alle	BS714	BS714	—	BS714
HONDA®	AFRICA TWIN	16 -	BS711 / BS787 ¹	BS711 / BS787 ¹	Inklusiv	BS711 / BS787 ¹
HONDA®	CB 500 F	16 -	BS711 / BS787 ¹	BS711 / BS787 ¹	Inklusiv	BS711 / BS787 ¹
HONDA®	CB 650 F	15 -	BS711 / BS787 ¹	BS711 / BS787 ¹	Inklusiv	BS711 / BS787 ¹
HONDA®	CB 1000 R	13 -	BS711 / BS787 ¹	BS711 / BS787 ¹	Inklusiv	BS711 / BS787 ¹
HONDA®	INTEGRA	12 -	BS711 / BS787 ¹	BS711 / BS787 ¹	Inklusiv	BS711 / BS787 ¹
HONDA®	NC700X	12 -	BS711 / BS787 ¹	BS711 / BS787 ¹	Inklusiv	BS711 / BS787 ¹
KAWASAKI®	ER-6N	12 -	BS711 / BS787 ¹	BS711 / BS787 ¹	Inklusiv	BS711 / BS787 ¹
KAWASAKI®	VERSYS 1000 ABS	12 -	BS711 / BS787 ¹	BS711 / BS787 ¹	Inklusiv	BS711 / BS787 ¹
KAWASAKI®	Z300	15 -	BS787	BS711 / BS787 ¹	Inklusiv	BS711 / BS787 ¹
KAWASAKI®	Z750R	11 -	BS787	BS787	Inklusiv	BS787
KAWASAKI®	Z800	13 -	BS787	BS787	Inklusiv	BS787
KAWASAKI®	Z1000	10 - 13	BS787	BS787	Inklusiv	BS787
KAWASAKI®	Z1000	14 -	BS711 / BS787 ¹	BS787	Inklusiv	BS787
KTM®	125 DUKE	15 -	BS711 / BS787 ¹	BS711 / BS787 ¹	Inklusiv	BS711 / BS787 ¹
KTM®	390 DUKE	15 -	BS711 / BS787 ¹	BS711 / BS787 ¹	Inklusiv	BS711 / BS787 ¹
MV AGUSTA®	BRUTALE 675	12 -	BS711	BS711	Inklusiv	BS711
MV AGUSTA®	BRUTALE 800 / 1090	13 - 15	BS711	BS711	Inklusiv	BS711
MV AGUSTA®	BRUTALE (Andere Modelle)	Alle	BS730	BS730	Inklusiv	BS730
MV AGUSTA®	RIVALE 800 EAS	13 -	BS871 ² BS870 ²	BS871 ² BS870 ²	BS871 ² BS870 ²	BS871 ² BS870 ²
SUZUKI®	GSF 600 BANDIT	00 - 05	BS787	BS787	Inklusiv	BS787
SUZUKI®	GSF 1200 BANDIT	01 - 06	BS787	BS787	Inklusiv	BS787
SUZUKI®	GSX-S 1000	15 -	BS711 / BS787 ¹	BS711 / BS787 ¹	Inklusiv	BS711 / BS787 ¹
TRIUMPH®	BONNEVILLE T100	08 -	BS804	BS804	Inklusiv	BS804
TRIUMPH®	BONNEVILLE T120	16 -	BS804	BS804	Inklusiv	BS804
TRIUMPH®	SPEED TRIPLE 1050 R	16 -	BS711 + BS770	BS711 + BS770	Inklusiv	Inklusiv
TRIUMPH®	STREET TRIPLE RX	15 -	BS711 / BS787 ¹	BS711 / BS787 ¹	Inklusiv	BS711 / BS787 ¹
TRIUMPH®	STREET TRIPLE / R	13 -	BS711 / BS787 ¹	BS711 / BS787 ¹	Inklusiv	BS711 / BS787 ¹
TRIUMPH®	STREET TWIN	16 -	BS797	BS797	Inklusiv	BS797
TRIUMPH®	TIGER 800 / EXPLORER	11 -	BS711 / BS787 ¹	BS711 / BS787 ¹	Inklusiv	BS711 / BS787 ¹
TRIUMPH®	THRUXTON	15 -	BS804	BS804	—	BS804
YAMAHA®	XV950R	14 -	BS711 / BS787 ¹	BS711 / BS787 ¹	Inklusiv	BS711 / BS787 ¹
YAMAHA®	T-MAX 500	08 - 11	BS775 / BS786 ⁴	BS775 / BS786 ⁴	—	BS775 / BS786 ⁴
YAMAHA®	T-MAX 530	12 -	BS775 / BS805 ⁴	BS775 / BS805 ⁴	—	BS775 / BS805 ⁴

¹ Wahlweise BS787 (h 57,5 mm) oder BS711 / BS715 (h 41,5 mm). Wahlweise BS487 (h 57 mm) oder BS411 (h 39 mm). Wählen Sie den passenden Adapter nach Fahrstil.

² BS716 links, BS717 rechts. BS416 links, BS417 rechts. BS870 links, BS871 rechts. BS870 / BS871 kompatibel mit den Original Handprotektoren montiert werden.

³ Der Artikel BS251 ist nur für HARLEY-DAVIDSON®, die passenden Adapter werden mitgeliefert.

⁴ BS786B / BS805B Spiegel-Adapter für Frontverkleidungen. BS775B Spiegel-Adapter für Lenker. Wir empfehlen die Spiegelbohr Abdeckungen BS522B für T-MAX 500 und BS806A für T-MAX 530.

SPIEGEL ADAPTER FÜR MODELLE MIT LENKERAUFNAHME / SCOOTER

Preise Spiegel-Adapter

■	■	Inklusiv
BS411A	BS411B	Schrauben M10x1,25x20 - M10x1,25x20SX - M10x20
BS414A	BS414B	Schrauben M8x50 - Unterlegscheibe Ø 8 - Mutter M8
BS487A	BS487B	Schrauben M8x40 - M8x40SX - M10x1,25x40 - M10x1,25x40SX - M10x40
BS711A	BS711B	Schrauben M10x1,25x20 - M10x1,25x20SX - M10x20 - M6x16
—	BS714B	Schrauben M8x75 - M8x50 - M8x65 - M6x16 - Spiegel Adapter-Bolzen M8-M10
—	BS715B	Schrauben M8x25 - M8x25SX - M6x16
—	BS716B	Schrauben M10x1,25x30 - M6x16
—	BS717B	Schrauben M10x1,25x30SX - M6x16
—	BS730B	Schrauben M6x16
—	BS736B	Schrauben M10x1,25x30SX - Schrauben M10x1,25x30 - M6x16
BS759A	BS759B	KIT
—	BS760B	Schrauben M8x45 - Steckachse L 126 mm M8
—	BS770B	KIT
—	BS775B	KIT
BS780H	—	Spiegel Adapter-Bolzen M8 - M8SX
—	BS786B	KIT
—	BS787B	Schrauben M10x1,25x40 - M10x1,25x40SX - M8x40 - M8x40SX - M10x40 - M6x16
—	BS790B	Schrauben M6x25 - M6x30 - M6x20
—	BS797B	Spiegel Adapter-Bolzen M10x1,25x50 - Schrauben M6x16
—	BS804B	Schrauben M8x50 - M6x16 - Unterlegscheibe Ø 8 - Mutter M8
—	BS805B	Schrauben M6x20 - M5x12
—	BS811B	Spiegel Adapter-Bolzen M10x1,25/M10 + Spiegel Adapter-Bolzen M10x1,25/M10-SX
—	BS812B	Spiegel Adapter-Bolzen M10x1,25/M10
—	BS813B	Spiegel Adapter-Bolzen M10x1,25/M10 - Unterlegscheibe Ø 10
—	BS814B	Spiegel Adapter-Bolzen M10x1,25/M6
—	BS815B	Spiegel Adapter-Bolzen M10x1,25/M8 - Spiegel Adapter-Bolzen M10x1,25/M8-SX
—	BS870B	Schrauben M6x20 - M5x10 - M6x16 - M10x1,25x20
—	BS871B	Schrauben M5x16 - M6x16 - M10x1,25x20



BS711B - BS714 - BS715 - BS736



BS770B



BS870



BS871

SPIEGEL ADAPTER FÜR MODELLE MIT FRONTVERKLEIDUNGEN

Marke	Modelle	Jahr	VELOCE SPORT BS205	RADIAL RS BS132	ELISSE BS171 / BS172	CIRCUIT 744 BS201 / BS202	TOMOK BS160 / BS162
BMW®	S 1000 RR	10 -	BS785B	BS785B	BS785B	BS785B	BS785B
BMW®	R 1200 RS ABS	15 -	BS759A/B	BS759A/B	BS759A/B	BS759A/B	BS759A/B
HONDA®	CBR 600 F	11 -	—	BS778B	BS778B	BS778B	BS778B
HONDA®	CBR 600 RR	03 - 08	BS721B	BS721B	BS721B	BS721B	BS721B
HONDA®	CBR 600 RR	09 -	BS778B	BS778B	BS778B	BS778B	BS778B
HONDA®	CBR 900 RR	02 - 04	BS721B	BS721B	BS721B	BS721B	BS721B
HONDA®	CBR 1000 RR	04 - 07	BS721B	BS721B	BS721B	BS721B	BS721B
KAWASAKI®	ER-6F	11 -	BS778B	BS778B	BS778B	BS778B	BS778B
KAWASAKI®	NINJA 300	15 -	BS779B	BS779B	BS779B	BS779B	BS779B
KAWASAKI®	NINJA 600 / 636 ZX-6R	05 - 08	BS721B	BS721B	BS721B	BS721B	BS721B
KAWASAKI®	NINJA 600 ZX-6R	09 -	BS779B	BS779B	BS779B	BS779B	BS779B
KAWASAKI®	NINJA 1000 ZX-10R	16 -	BS792B	BS792B	BS792B	BS792B	BS792B
KAWASAKI®	NINJA 1000 ZX-10R	04 - 07	BS721B	BS721B	BS721B	BS721B	BS721B
SUZUKI®	GSF 600 S BANDIT	00 - 05	BS726B	BS726B	BS726B	BS726B	BS726B
SUZUKI®	GSF 1200 S BANDIT	01 - 06	BS726B	BS726B	BS726B	BS726B	BS726B
SUZUKI®	GSF 650 / 1250 S BANDIT	07 -	BS778B	BS778B	BS778B	BS778B	BS778B
SUZUKI®	GSX F 650 / 1250 BANDIT	08 -	BS778B	BS778B	BS778B	BS778B	BS778B
SUZUKI®	GSX FA 1250 BANDIT	10 -	BS778B	BS778B	BS778B	BS778B	BS778B
SUZUKI®	GSX-R 600	01 - 05	BS726B	BS726B	BS726B	BS726B	BS726B
SUZUKI®	GSX-R 750	00 - 05	BS726B	BS726B	BS726B	BS726B	BS726B
SUZUKI®	GSX-R 1000	00 - 04	BS726B	BS726B	BS726B	BS726B	BS726B
SUZUKI®	SV 650 S	03 -	BS726B	BS726B	BS726B	BS726B	BS726B
SUZUKI®	SV 1000 S	03 - 06	BS726B	BS726B	BS726B	BS726B	BS726B
TRIUMPH®	DAYTONA 675	06 - 08	BS724B	BS724B	BS724B	BS724B	BS724B
TRIUMPH®	DAYTONA 675 R	13 -	BS791B	BS791B	BS791B	BS791B	BS791B
TRIUMPH®	DAYTONA 675 R	11 - 12	BS777B	BS777B	BS777B	BS777B	BS777B
TRIUMPH®	DAYTONA 675	09 - 12	BS777B	BS777B	BS777B	BS777B	BS777B
YAMAHA®	FZ1 FAZER	06 -	BS734B	BS734B	BS734B	BS734B	BS734B
YAMAHA®	FZ6 FAZER	04 - 08	BS724B	BS724B	BS724B	BS724B	BS724B
YAMAHA®	YZF-R1	09 - 14	BS777B	BS777B	BS777B	BS777B	BS777B
YAMAHA®	YZF-R1	02 - 08	BS724B	BS724B	BS724B	BS724B	BS724B
YAMAHA®	YZF-R6	08 - 16	BS771B	BS771B	BS771B	BS771B	BS771B
YAMAHA®	YZF-R6	03 - 07	BS724B	BS724B	BS724B	BS724B	BS724B

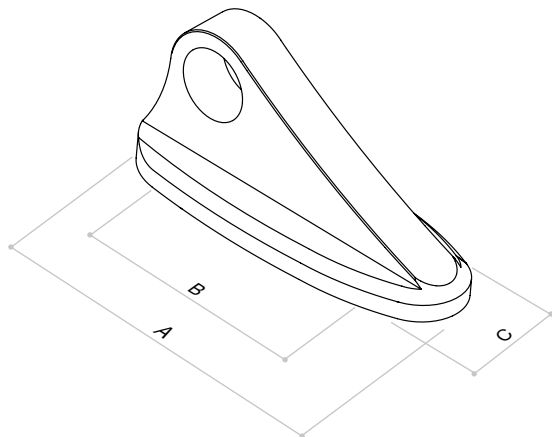

Preise Spiegel-Adapter

■	A (mm)	B (mm)	C (mm)
BS721B	60	40	28
BS724B	51	28.5	20
BS725B	48	28 - 30	20
BS726B	72	42	28
BS734B	71.5	40	27
BS735B	60	36 - 38	20
BS743B	60	40 - 42	20
BS771B	55	28	27
BS772B	78.3	44	34.6
BS777B	48	28 - 30	20
BS778B	60	40 - 42	20
BS779B	67	47	20
BS785B	48	28 - 30	20
BS788B	53.5	33.5	31.2
BS789B	52.3	37	20
BS791B	67	47	20
BS792B	63.5	46.5	20
BS808B	67	47	20
BS817B	53	27	41

*Paar

SPIEGEL ADAPTER "VELOCE L" MIT INTEGRIERTEN BLINKER

Marke	Modelle	Jahr	VELOCE L SPORT BS305
APRILIA®	RSV4	09 -	BS735B
BMW®	S 1000 RR	10 -	BS785B
DUCATI®	899 PANIGALE	14 -	BS789B
DUCATI®	1199 PANIGALE / PANIGALE S	12 -	BS789B
DUCATI®	1299 PANIGALE / PANIGALE S	15 -	BS817B
DUCATI®	848 / 1098 / 1198	06 -	BS788B
HONDA®	CBR 1000 RR	08 -	BS772B
KAWASAKI®	NINJA 1000 ZX-10R	16 -	BS792B
KAWASAKI®	NINJA 1000 ZX-10R	11 - 15	BS808B
KAWASAKI®	NINJA 1000 ZX-10R	08 - 10	BS743B
MV AGUSTA®	F3 675	12 -	BS743B
MV AGUSTA®	F4 1000	10 -	BS743B
SUZUKI®	GSX-R 600	06 -	BS743B
SUZUKI®	GSX-R 750	06 -	BS743B
SUZUKI®	GSX-R 1000	05 -	BS743B
YAMAHA®	YZF-R1	15 -	BS725B



LENKER-SPIEGELADAPTER

FÜR MODELLE MIT LENKERAUFNAHME / SCOOTER

Marke	Modelle	Jahr	SPIRIT RS BS192	SPY-R 60 BS185	SPY-R 80 BS285	SPY-R 100 BS294
Universal	Alle	Alle	Inklusiv	LP200B	LP200B	LP200B
Ausser						
BMW®	C 600 SPORT / C 650 GT	12 -	LP323B	LP323B	LP323B	LP323B
BMW®	F 800 R	09 - 14	LP322B	LP322B	LP322B	LP322B
BMW®	K 1200 R	05 - 08	LP305B	LP305B	LP305B	LP305B
BMW®	K 1300 R	09 - 11	LP320B	LP320B	LP320B	LP320B
BMW®	R 1200 GS	13 -	—	LP324B	LP324B	LP324B
BMW®	R 1200 GS	04 - 12	—	—	—	—
BMW®	R 1200 GS ADVENTURE	14 -	—	LP324B	LP324B	LP324B
BMW®	R 1200 GS ADVENTURE	10 - 13	—	—	—	—
BMW®	R 1200 R / R CLASSIC	15 -	LP324B	LP324B	LP324B	LP324B
BMW®	R 1200 R / R CLASSIC	06 - 14	LP320B	LP320B	LP320B	LP320B
BMW®	R nineT	14 -	LP325B	LP325B	LP325B	LP325B
BMW®	R nineT Scrambler	16 -	LP325B	LP325B	LP325B	LP325B
BMW®	S 1000 XR	15 -	—	LP324B ³	LP324B ³	LP324B ³
BMW®	S 1000 R	14 -	LP325B	LP325B	LP325B	LP325B
HARLEY-DAVIDSON®	SOFTAIL SLIM	16 -	BS830B ³	BS830B ³	BS830B ³	BS830B ³
HARLEY-DAVIDSON®	Andere Modelle	Alle	LP400B	LP400B	LP400B	LP400B
KAWASAKI®	ER-6N	12 -	LP305B	LP305B	LP305B	LP305B
KAWASAKI®	Z300	15 -	LP305B	LP305B	LP305B	LP305B
KAWASAKI®	Z750R	11 -	LP305B	LP305B	LP305B	LP305B
KAWASAKI®	Z800	13 -	LP305B	LP305B	LP305B	LP305B
KAWASAKI®	Z1000	10 -	LP305B	LP305B	LP305B	LP305B
KAWASAKI®	VERSYS 1000 ABS	12 -	LP305B	LP305B	LP305B	LP305B
KTM®	125 DUKE	15 -	—	Inklusiv	Inklusiv	Inklusiv
KTM®	390 DUKE	15 -	—	Inklusiv	Inklusiv	Inklusiv
MV AGUSTA®	BRUTALE 675	12 -	LP335B	LP335B	LP335B	LP335B
MV AGUSTA®	BRUTALE 800 / 1090	13 - 15	LP335B	LP335B	LP335B	LP335B
MV AGUSTA®	BRUTALE (Andere Modelle)	Alle	Inklusiv	LP200B	LP200B	LP200B
MV AGUSTA®	RIVALE 800 EAS ¹	14 -	LP335B	LP335B	LP335B	LP335B
TRIUMPH®	BONNEVILLE T100	14 -	—	BS816B	BS816B	BS816B
TRIUMPH®	BONNEVILLE T120	16 -	—	—	—	—
TRIUMPH®	SPEED TRIPLE 1050 / 1050 R	11 - 15	LP310B	LP310B	LP310B	LP310B
TRIUMPH®	SPEED TRIPLE 1050 R	16 -	—	BS819B	BS819B	BS819B
TRIUMPH®	STREET TRIPLE / R / RX	13 -	—	Inklusiv	Inklusiv	Inklusiv
TRIUMPH®	STREET TRIPLE / R	07 - 12	LP310B	LP310B	LP310B	LP310B
TRIUMPH®	STREET TWIN	16 -	—	BS819B	BS819B	BS819B
TRIUMPH®	SCRAMBLER 900	15 -	—	BS816B	BS816B	BS816B
TRIUMPH®	THRUXTON	15 -	—	BS816B	BS816B	BS816B
TRIUMPH®	THRUXTON R	16 -	Inklusiv ²	LP200B ²	LP200B ²	LP200B ²
TRIUMPH®	TIGER 800	11 -	Inklusiv	Inklusiv	Inklusiv	Inklusiv
TRIUMPH®	TIGER EXPLORER	12 -	Inklusiv	Inklusiv	Inklusiv	Inklusiv
YAMAHA®	XJR 1300	15 -	LP300B	LP300B	LP300B	LP300B
YAMAHA®	MT-09 TRACER / FJ-09 ¹	15 -	LP335B	LP335B	LP335B	LP335B
YAMAHA®	MT-09 / FZ-09	13 - 16	LP300B	LP300B	LP300B	LP300B
YAMAHA®	MT-07 / FZ-07	14 -	LP300B	LP300B	LP300B	LP300B
YAMAHA®	MT-10 / FZ-10	16 -	Inklusiv	LP300B	LP300B	LP300B
YAMAHA®	XSR 700	16 -	LP300B	LP300B	LP300B	LP300B
YAMAHA®	XSR 900	16 -	LP300B	LP300B	LP300B	LP300B
YAMAHA®	XJ6	08 -	LP300B	LP300B	LP300B	LP300B
YAMAHA®	T-MAX 500	08 - 11	LP300B	LP300B	LP300B	LP300B
YAMAHA®	T-MAX 530	12 -	LP300B	LP300B	LP300B	LP300B

¹ Kann nicht in Kombination mit den Original Handprotektoren montiert werden.

² Nur am Rizoma Stummel-Lenker montierbar, mit dem OEM-Lenker nicht verwendbar.

³ Lenkerendspiegel nur links passend.

LENKER-SPIEGELADAPTER FÜR MODELLE MIT LENKERAUFNAHME / SCOOTER

Marke	Modelle	Jahr	SPY-ARM 80 BS300	SPY-ARM 100 BS303	CLASS RETRO BS144	REVERSE RETRO BS070
Universal	Alle	Alle	LP200B	LP200B	MA534 / MA533	MA534 / MA533
Ausser						
BMW®	C 600 SPORT / C 650 GT	12 -	LP323B	LP323B	LP323 + MA533	LP323 + MA533
BMW®	F 800 R	09 - 14	LP322B	LP322B	LP322 + MA533	LP322 + MA533
BMW®	K 1200 R	05 - 08	LP305B	LP305B	MA534 / MA533	MA534 / MA533
BMW®	K 1300 R	09 - 11	LP320B	LP320B	—	—
BMW®	R 1200 GS	13 -	LP324B	LP324B	LP324 + MA533	LP324 + MA533
BMW®	R 1200 GS	04 - 12	—	—	MA525	MA525
BMW®	R 1200 GS ADVENTURE	14 -	LP324B	LP324B	LP324 + MA533	LP324 + MA533
BMW®	R 1200 GS ADVENTURE	10 - 13	—	—	MA525	MA525
BMW®	R 1200 R / R CLASSIC	15 -	LP324B	LP324B	LP324 + MA533	LP324 + MA533
BMW®	R 1200 R / R CLASSIC	06 - 14	LP320B	LP320B	—	—
BMW®	R nineT	14 -	LP325B	LP325B	LP325B + MA534 / MA533	LP325B + MA534 / MA533
BMW®	R nineT Scrambler	16 -	LP325B	LP325B	LP325B + MA534 / MA533	LP325B + MA534 / MA533
BMW®	S 1000 XR	15 -	LP324B / BS755B ³	LP324B / BS755B ³	LP324B / BS755B ³	LP324B / BS755B ³
BMW®	S 1000 R	14 -	LP325B	LP325B	LP321B + MA534 / MA533	LP321B + MA534 / MA533
HARLEY-DAVIDSON®	SOFTAIL SLIM	16 -	BS830B ⁵	BS830B ⁵	BS831B ⁵	BS831B ⁵
HARLEY-DAVIDSON®	Andere Modelle	Alle	LP400B	LP400B	—	—
KAWASAKI®	ER-6N	12 -	LP305B	LP305B	—	—
KAWASAKI®	Z300	15 -	LP305B	LP305B	—	—
KAWASAKI®	Z750R	11 -	LP305B	LP305B	—	—
KAWASAKI®	Z800	13 -	LP305B	LP305B	—	—
KAWASAKI®	Z1000	10 -	LP305B	LP305B	—	—
KAWASAKI®	VERSYS 1000 ABS	12 -	LP305B	LP305B	—	—
KTM®	125 DUKE	15 -	Inklusiv	Inklusiv	MA534 / MA533	MA534 / MA533
KTM®	390 DUKE	15 -	Inklusiv	Inklusiv	MA534 / MA533	MA534 / MA533
MV AGUSTA®	BRUTALE 675	12 -	LP335B	LP335B	MA534 / MA533	MA534 / MA533
MV AGUSTA®	BRUTALE 800 / 1090	13 - 15	LP335B	LP335B	MA534 / MA533	MA534 / MA533
MV AGUSTA®	BRUTALE (Andere Modelle)	Alle	LP200B	LP200B	MA534 / MA533	MA534 / MA533
MV AGUSTA®	RIVALE 800 EAS2	14 -	LP335B	LP335B	MA534 / MA533	MA534 / MA533
TRIUMPH®	TIGER 800	11 -	Inklusiv	Inklusiv	MA534 / MA533	MA534 / MA533
TRIUMPH®	TIGER EXPLORER	12 -	Inklusiv	Inklusiv	MA534 / MA533	MA534 / MA533
TRIUMPH®	SPEED TRIPLE 1050 / 1050 R	11 - 15	LP310B	LP310B	—	—
TRIUMPH®	SPEED TRIPLE 1050 R	16 -	BS818	BS818	BS818	BS818
TRIUMPH®	STREET TRIPLE / R / RX	13 -	Inklusiv	Inklusiv	—	—
TRIUMPH®	STREET TRIPLE / R	07 - 12	LP310B	LP310B	—	—
TRIUMPH®	STREET TWIN	16 -	BS818	BS818	BS818	BS818
TRIUMPH®	SCRAMBLER 900	15 -	BS816B	BS816B	—	—
TRIUMPH®	THRUXTON	15 -	BS816B	BS816B	BS816B + MA534 / MA533	BS816B + MA534 / MA533
TRIUMPH®	THRUXTON R	16 -	LP200B ⁴	LP200B ⁴	MA534 / MA533 ⁴	MA534 / MA533 ⁴
TRIUMPH®	BONNEVILLE T100	14 -	BS816B	BS816B	BS816B + MA534 / MA533	BS816B + MA534 / MA533
TRIUMPH®	BONNEVILLE T120	16 -	—	—	Inklusiv	Inklusiv
YAMAHA®	XJR 1300	15 -	LP300B	LP300B	MA534 / MA533 ¹	MA534 / MA533 ¹
YAMAHA®	MT-09 TRACER / FJ-09 ²	15 -	LP335B	LP335B	MA534 / MA533 ¹	MA534 / MA533 ¹
YAMAHA®	MT-09 / FZ-09	13 -	LP300B	LP300B	MA534 / MA533 ¹	MA534 / MA533 ¹
YAMAHA®	MT-07 / FZ-07	14 -	LP300B	LP300B	MA534 / MA533 ¹	MA534 / MA533 ¹
YAMAHA®	MT-10 / FZ-10	16 -	LP300B	LP300B	MA534 / MA533	MA534 / MA533
YAMAHA®	XSR 700	16 -	LP300B	LP300B	MA534 / MA533	MA534 / MA533
YAMAHA®	XSR 900	16 -	LP300B	LP300B	MA534 / MA533	MA534 / MA533
YAMAHA®	XJ6	08 -	LP300B	LP300B	MA534 / MA533 ¹	MA534 / MA533 ¹
YAMAHA®	T-MAX 500	08 - 11	LP300B	LP300B	MA534 / MA533 ¹	MA534 / MA533 ¹
YAMAHA®	T-MAX 530	12 -	LP300B	LP300B	MA534 / MA533 ¹	MA534 / MA533 ¹

¹ Adapter MA600 erforderlich.

² Kann nicht in Kombination mit den Original Handprotektoren montiert werden.

³ Die Lenkerend-Spiegel BS300 / BS303 / BS070 / BS144. werden mit dem Adapter BS755B montiert und sind mit den OEM Handschützern kompatibel. Mit adapter LP324 die OEM Handschützer müssen entfernt werden.

⁴ LP200/MA534/MA533 notwendig, nur mit Rizoma Stummel-Lenker Kit MA053. Adapter für OEM-Lenker nicht benötigt.

⁵ Lenkerendspiegel nur links passend.

LENKER-SPIEGELADAPTER FÜR MODELLE MIT FRONTVERKLEIDUNGEN

Marke	Modelle	Jahr	SPY-R 60 BS18	SPY-R 80 BS285	SPY-R 100 BS294	CLASS RETRO BS144	REVERSE RETRO BS070
APRILIA®	RSV4	09 -	LP200B	LP200B	LP200B	MA534 / MA533	MA534 / MA533
BMW®	S 1000 RR	10 -	LP321B	LP321B	LP321B	LP321 + MA533	LP321 + MA533
DUCATI®	848 / 1098 / 1198	06 -	LP200B	LP200B	LP200B	MA534 / MA533	MA534 / MA533
HONDA®	CBR 600 F	11 -	LP200B	LP200B	LP200B	MA534 / MA533	MA534 / MA533
HONDA®	CBR 600 F	99 - 06	LP200B	LP200B	LP200B	MA534 / MA533	MA534 / MA533
HONDA®	CBR 600 RR	03 -	LP200B	LP200B	LP200B	MA534 / MA533	MA534 / MA533
HONDA®	CBR 900 RR	02 - 04	LP200B	LP200B	LP200B	MA534 / MA533	MA534 / MA533
HONDA®	CBR 1000 RR	04 -	LP200B	LP200B	LP200B	MA534 / MA533	MA534 / MA533
HONDA®	HORNET 600 S	02 - 04	LP200B	LP200B	LP200B	MA534 / MA533	MA534 / MA533
HONDA®	VTR 1000 SP-1 / SP-2	00 - 06	LP200B	LP200B	LP200B	MA534 / MA533	MA534 / MA533
KAWASAKI®	ER-6F	06 -	LP305B	LP305B	LP305B	—	—
KAWASAKI®	NINJA 300	15 -	LP305B	LP305B	LP305B	—	—
KAWASAKI®	NINJA 600 / 636 ZX-6R	00 -	LP305B	LP305B	LP305B	—	—
KAWASAKI®	NINJA 600 ZX-6R	09 -	LP305B	LP305B	LP305B	—	—
KAWASAKI®	NINJA 900 ZX-9R	98 - 05	LP305B	LP305B	LP305B	—	—
KAWASAKI®	NINJA 1000 ZX-10R	04 -	LP305B	LP305B	LP305B	—	—
MV AGUSTA®	F3 675	12 -	LP200B	LP200B	LP200B	MA534 / MA533	MA534 / MA533
MV AGUSTA®	F4 1000	10 -	LP200B	LP200B	LP200B	MA534 / MA533	MA534 / MA533
SUZUKI®	GSF 600 S BANDIT	00 - 05	LP200B	LP200B	LP200B	MA534 / MA533	MA534 / MA533
SUZUKI®	GSF 1200 S BANDIT	01 - 06	LP200B	LP200B	LP200B	MA534 / MA533	MA534 / MA533
SUZUKI®	GSF 650 / 1250 S BANDIT	07 -	LP200B	LP200B	LP200B	MA534 / MA533	MA534 / MA533
SUZUKI®	GSX F 650 / 1250 BANDIT	08 -	LP200B	LP200B	LP200B	MA534 / MA533	MA534 / MA533
SUZUKI®	GSX FA 1250 BANDIT	10 -	LP200B	LP200B	LP200B	MA534 / MA533	MA534 / MA533
SUZUKI®	GSX-R 600	01 -	LP200B	LP200B	LP200B	MA534 / MA533	MA534 / MA533
SUZUKI®	GSX-R 750	99 -	LP200B	LP200B	LP200B	MA534 / MA533	MA534 / MA533
SUZUKI®	GSX-R 1000	00 -	LP200B	LP200B	LP200B	MA534 / MA533	MA534 / MA533
SUZUKI®	SV 650 S	03 -	LP200B	LP200B	LP200B	MA534 / MA533	MA534 / MA533
SUZUKI®	SV 1000 S	03 - 06	LP200B	LP200B	LP200B	MA534 / MA533	MA534 / MA533
TRIUMPH®	DAYTONA 675 /675 R	09 -	LP200B	LP200B	LP200B	MA534 / MA533	MA534 / MA533
TRIUMPH®	DAYTONA 675	06 - 08	LP200B	LP200B	LP200B	MA534 / MA533	MA534 / MA533
YAMAHA®	FZ1 FAZER	06 -	LP300B	LP300B	LP300B	MA534 / MA533 ¹	MA534 / MA533 ¹
YAMAHA®	FZ6 FAZER	04 - 08	LP300B	LP300B	LP300B	MA534 / MA533 ¹	MA534 / MA533 ¹
YAMAHA®	YZF-R1	00 -	Inklusiv	Inklusiv	Inklusiv	MA534 / MA533 ¹	MA534 / MA533 ¹
YAMAHA®	YZF-R6	06 - 16	Inklusiv	Inklusiv	Inklusiv	MA534 / MA533 ¹	MA534 / MA533 ¹
YAMAHA®	YZF-R6	99 - 05	LP200B	LP200B	LP200B	MA534 / MA533 ¹	MA534 / MA533 ¹

¹ Adapter MA600 erforderlich.

PREISE UND TECHNISCHE INFORMATIONEN LENKER-SPIEGELADAPTER

■	■	■	■	■	
—	BS830B	—	—	—	(Pro Stück)
—	BS831B	—	—	—	(Pro Stück)
—	BS816B	—	—	—	(Pro Stück)
BS818A	BS818B	—	—	—	(Pro Stück)
—	BS819B	—	—	—	(Pro Stück)
—	BS755B	—	—	—	(Pro Stück)
—	LP200B	—	—	—	(Pro Stück)
—	LP300B	—	—	—	(Pro Stück)
—	LP305B	—	—	—	(Pro Stück)
—	LP310B	—	—	—	(Pro Stück)
—	LP320B	—	—	—	(Pro Stück)
—	LP321B	—	—	—	(Pro Stück)
—	LP322B	—	—	—	(Pro Stück)
—	LP323B	—	—	—	(Pro Stück)
—	LP324B	—	—	—	(Pro Stück)
—	LP335B	—	—	—	(Pro Stück)
—	LP400B	—	—	—	(Pro Stück)
MA534A	MA534B	MA534G	MA534R	MA534U	(Paar)
MA533A	MA533B	MA533G	MA533R	MA533U	(Paar)
—	MA525B	—	—	—	(Pro Stück)

BS755

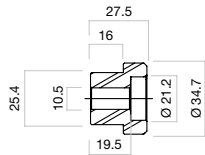

LP200B

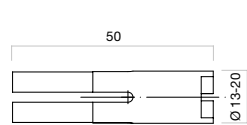

LP300B

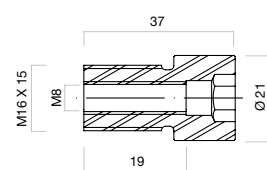

LP305B

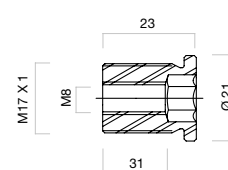

LP310B

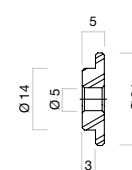

LP320B

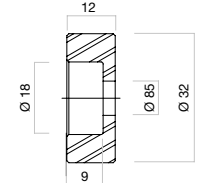

LP321B

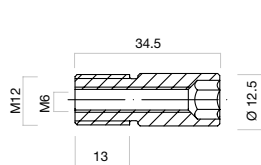

LP322B

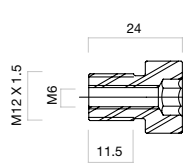

LP323B

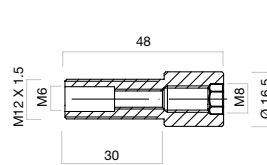

LP335B

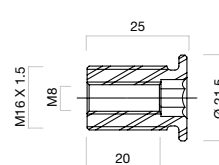

LP400B

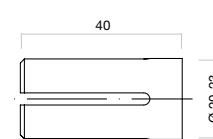

MA525B

