

BACK

FRONT

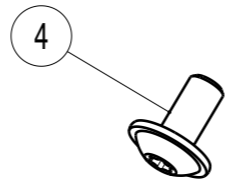
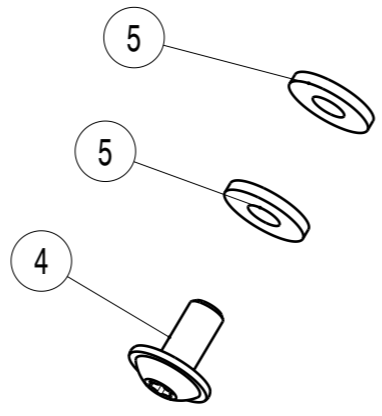
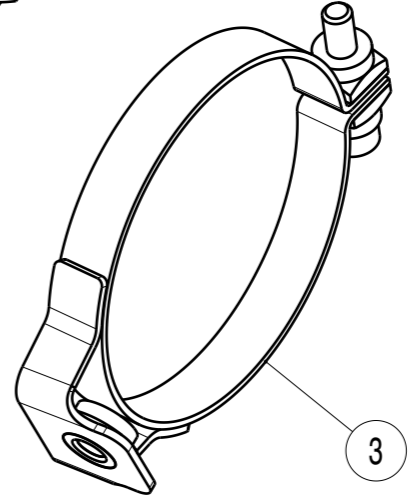
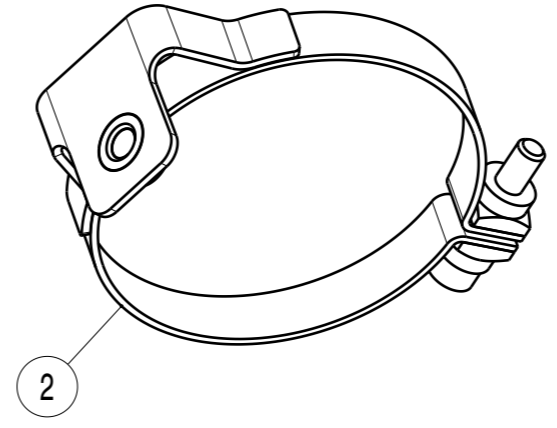
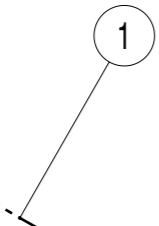
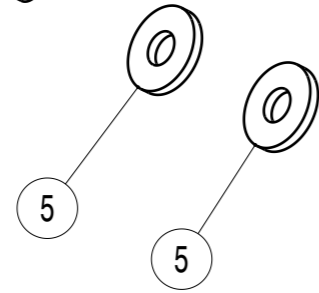
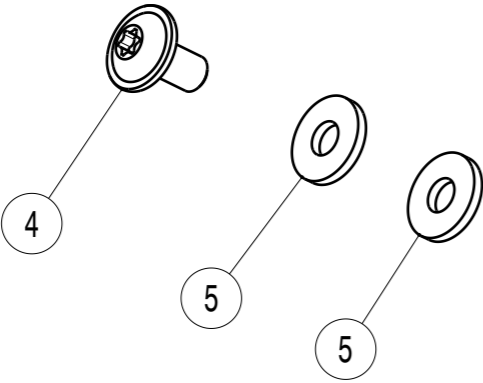
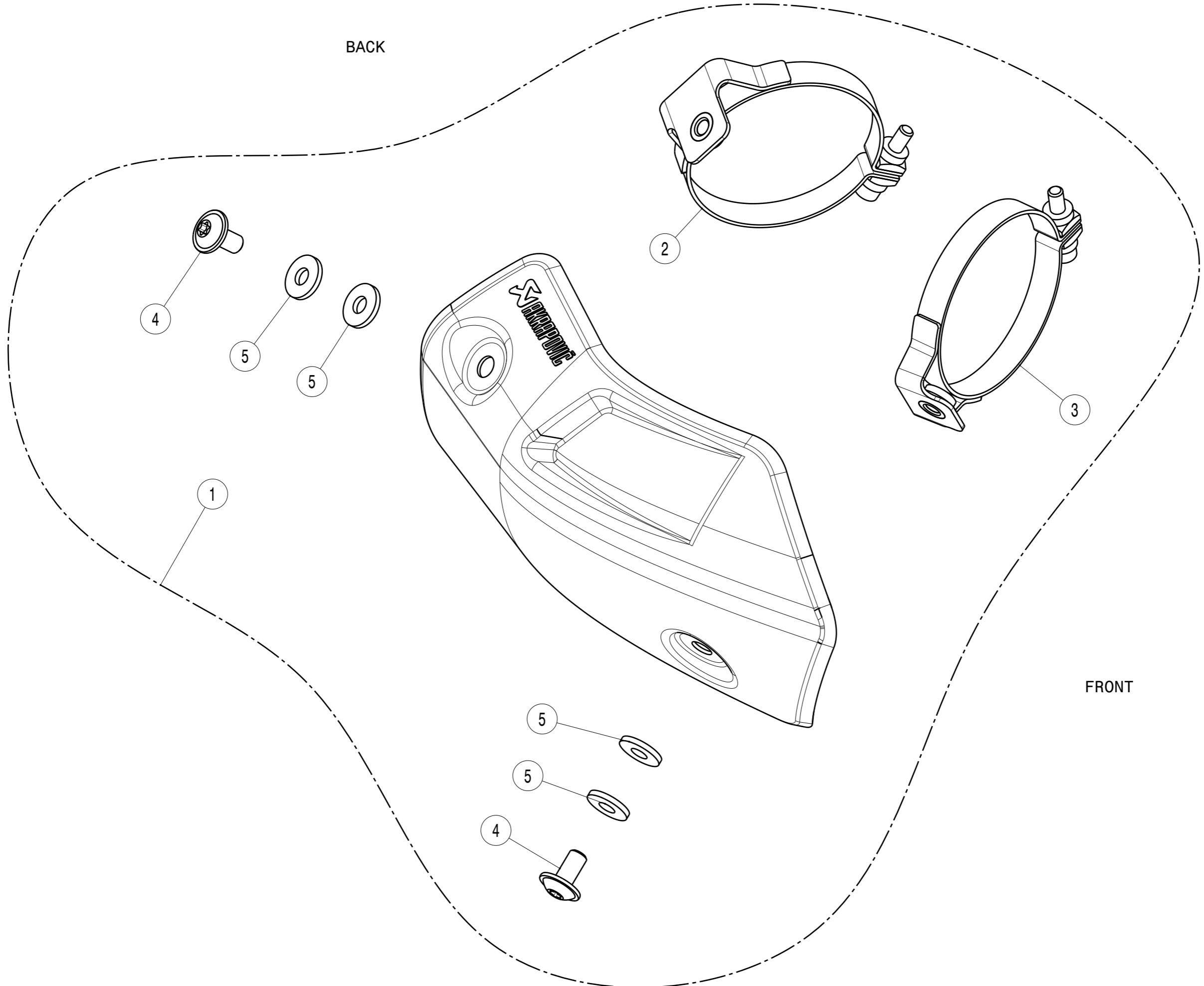

No.	SalesCode	Description	Qty.
1	P-HSH7SO2	heat shield CA Opt.	1
2	P-R211	clamp	1
3	P-R210	clamp	1
4	P-FB157	bolt	2
5	P-DRH2/BAR316	washer SS	4