

Kit Contents

Description	Part No	Pcs
Screw M6x16	01046-01	4
Reservoir bracket	61125-15	2
Bracket	61125-16	2
Screw Button head 5/16" x 1-3/4"	03128-06	4
Sleeve 9/14.5-14.2	61122-01	2
Sleeve 9/14.5-23.1	61122-03	2

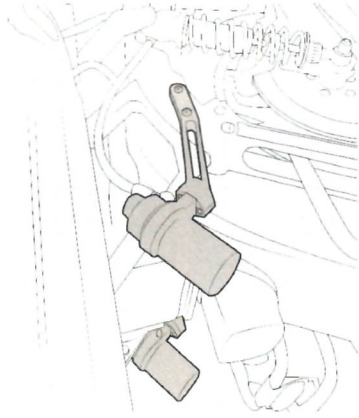

Note

Please note that this image is a general representation of the product and may differ slightly from your product.

Note

Before installing this product, check the contents of the kit. If anything is missing, please contact an Öhlins dealer.

Note

Please note that during storage and transportation, especially at high ambient temperature, some of the oil and grease used for assembling may leak and stain the packaging. This is in no way detrimental to the product, wipe off the excessive oil/grease with a cloth.

Warning!

Before installing this product, read the Öhlins Owner's Manual. The shock absorber/front fork/steering damper is an important part of your vehicle and will affect the stability.

Reservoir bracket kit for HD 044

65006-10

Mounting Instructions

RESERVOIR BRACKET KIT HD 044

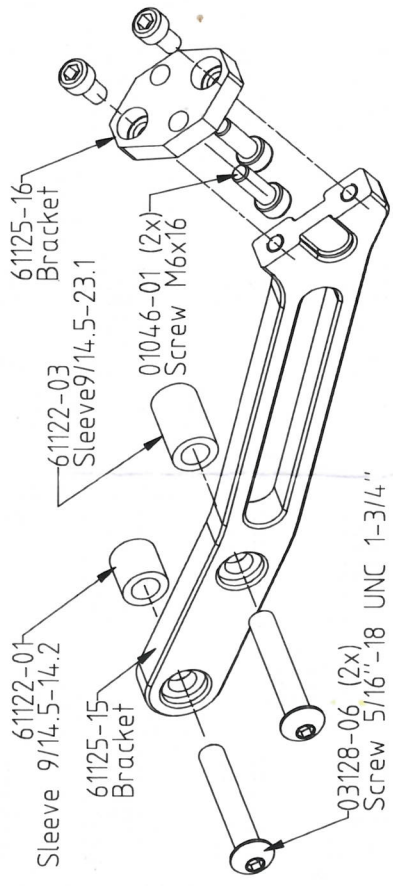

MOUNTING INSTRUCTIONS TO EXPOSE RESERVOIRS

1. After shocks are installed, remove the 2 OEM bolts from the saddle bag support frame.
2. Pre-assemble the reservoir brackets
 - a. Attach supplied adapter plate (61125-16) to bracket (61125-15) with the provided M6x10 bolts (01046-60). Use blue Loctite 242 on bolts before threading them through the counter-bored holes in the adapter plate.
 - b. Attach gold reservoir bracket (03102-5) to the adapter plate with the M6x16 bolts (01046-01). Use blue Loctite 242 on bolts.

Note!

The orientation of the pinch bolt cavity of bracket 03102-05 will determine the side of the bike the assembly will be installed on. Make sure to flip this bracket when building the assembly for the opposite side to have a designated left and right side once you're done. The pinch bolts will always face towards the center of the bike if assemblies are installed and built properly.

- c. With some blue Loctite 242, Loosely install the pinch bolt (00382-16) into the

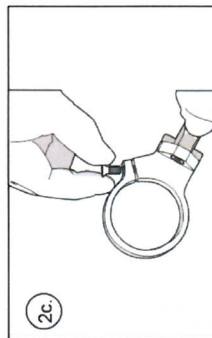
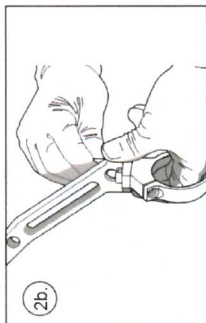
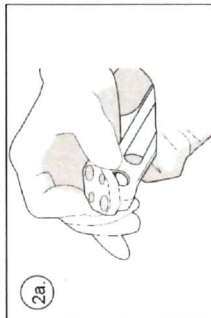
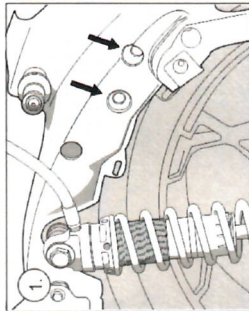

MOUNTING INSTRUCTIONS TO EXPOSE RESERVOIRS

3. Installing the reservoir bracket assemblies
 - a. Install reservoir into the bracket but do not tighten the pinch bolt yet.
 - b. Reservoir bracket assemblies should be installed as shown below, with the pinch bolt oriented towards the inside of the bike.
 - c. Install bracket assembly to saddle bag support frame using 1 short spacer (61122-01) towards the front of the bike and 1 long spacer (61122-03) towards the rear. Use 2 of the 1-3/4" long button head screws (03128-06) to fasten onto frame using blue Loctite 242.

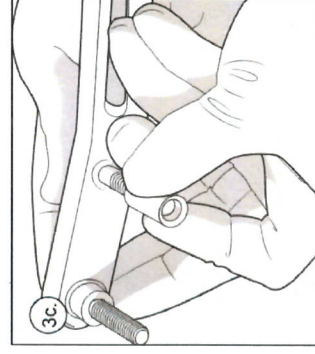
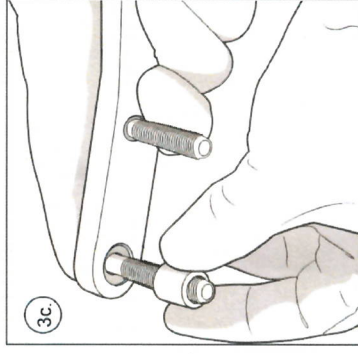
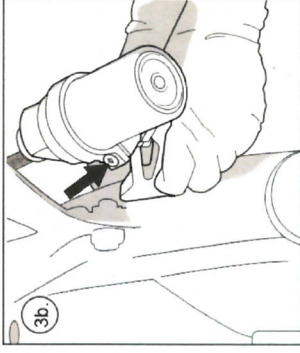

MOUNTING INSTRUCTIONS TO EXPOSE RESERVOIRS

- d. Clock the reservoir in the reservoir bracket so that the head of the banjo bolt is oriented towards the damper, and that the clamping surface on the reservoir is centered in the clamp, then tighten the pinch bolt to finish installation on this side.
- e. Repeat process for the other side.

