



Installation instructions

Akrapovič Exhaust System:
Evolution
for the
Mercedes-AMG C63 (type 205)

ENGLISH
Version 1.0

07/2016



www.akrapovic.com



Installation instructions

Akrapovič Exhaust System:
Evolution
for the
Mercedes-AMG C63 (type 205)

ENGLISH
Version 1.0

07/2016

www.akrapovic.com

Congratulations on purchasing the Akrapovič exhaust system. The Akrapovič exhaust system is a product of Akrapovič d.d., Malo Hudo 8a, 1295 Ivančna Gorica, Slovenia ("Akrapovič").

Please read this entire installation manual carefully prior to installing and using the Akrapovič exhaust system.

Akrapovič exhaust system should only be installed by persons skilled in car exhaust system installation and performance. The instructions provided in this manual should be followed to ensure proper installation and safe use of the Akrapovič exhaust system. Akrapovič and/or its partners shall not be held liable for any damage or personal injury (including direct, indirect, or consequential damage) sustained as a result of improper installation of the Akrapovič exhaust system or its use and maintenance contrary to the instructions and warnings contained herein.

If you have any questions regarding the installation and/or proper use of the Akrapovič exhaust system or this manual, please contact your local Akrapovič partner.

For more information on the Akrapovič exhaust systems, see the official Akrapovič website at: <http://www.akrapovic.com>

GENERAL INFORMATION

Your safety is our number one priority. Please drive your car responsibly, safely and always obey local traffic rules.

All statements made with regard to the exhaust system's compliance are made in respect of the exhaust system "as is". Any modifications of the Akrapovič exhaust system or its improper installation, use or maintenance that is not in accordance with this Installation manual, may result in severe damage to the exhaust system and/ or engine, as well as personal injury, and may affect the exhaust system's compliance with the legal requirements, such as exhaust system's air and/ or noise emissions (as an example, the car may not be suitable for use on public roads any longer), as well as warranty coverage.

The exhaust system may only be used in accordance with relevant laws and regulations, including state and federal, where applicable.

Damage caused by improper installation, use and maintenance of the Akrapovič exhaust system is not covered by the Akrapovič warranty. Please refer to the enclosed warranty with regard to the terms of our warranty.

Technical specifications of Akrapovič exhaust systems and related products are subject to change without notice.

COPYRIGHT AND OTHER RIGHTS NOTICE

The Akrapovič trademark, including corporate logos and emblems, are subject to copyright as well as trademark rights of Akrapovič, its licensors, or third persons authorizing Akrapovič to use them.

Any reproduction, technical or other manipulation, translation, or other use of the copyright and/or trademark rights contained herein is prohibited without the explicit prior written consent of Akrapovič. The same especially applies to the entire contents of this manual and/or any of its parts, including but not limited to technical specifications, instructions, graphs, photographs, and so on included in this manual.

Akrapovič takes all copyright and other rights infringement cases under serious consideration. If you have any reason to believe that your exhaust system is not an original Akrapovič product, please contact our local partners or Akrapovič at info@akrapovic.com.

SAFETY AND COMPLIANCE WARNING, PLEASE READ CAREFULLY

BEFORE REMOVING THE STOCK EXHAUST SYSTEM AND BEGINNING THE INSTALLATION OF YOUR NEW AKRAPOVIČ EXHAUST, PLEASE MAKE SURE THAT ALL ITEMS LISTED BELOW ARE VERIFIED:

- This manual is specific to the car indicated on the cover page, for which it is designed. Installation procedures vary depending on the type of car. Please verify that the Akrapovič **exhaust system and this installation manual correspond to the type of your car.**
- The exhaust system can get extremely hot during and after it is used. Make sure not to touch the exhaust system until it is completely cool. **Allow the exhaust and engine to cool down before beginning installation.**
- Make sure the car is **securely positioned to prevent** damage to yourself and other, or the car.
- Please check the parts you received against the parts list available on our website (please use the QR code on the front page or look for “schematic view” in the respective product page on www.akrapovic.com). Make sure that you have **all the parts necessary for the installation** of your new Akrapovič exhaust system. If any of the parts is missing, please do not proceed with uninstalling your stock exhaust system/installing the Akrapovič exhaust system and contact the retailer where you purchased the Akrapovič exhaust system.
- Every exhaust system muffler has its unique serial number, which identifies the authenticity of the product. You can find the serial number on the muffler’s sleeve. Please refer to the **picture 1** below. Please verify that your exhaust system is an original Akrapovič product. If you have any doubts, please contact the reseller where you purchased the exhaust system or Akrapovič partners. This manual, any certificates and Akrapovič warranty apply to original products only.

GENERAL NOTE

Photographs and other illustrations in this manual are symbolic and are intended to help represent individual steps for proper installation and use, as well as for a general overview. The actual component parts of the Akrapovič exhaust system may not entirely correspond to the photographs and other illustrations.

Picture 1 - Serial Number Position

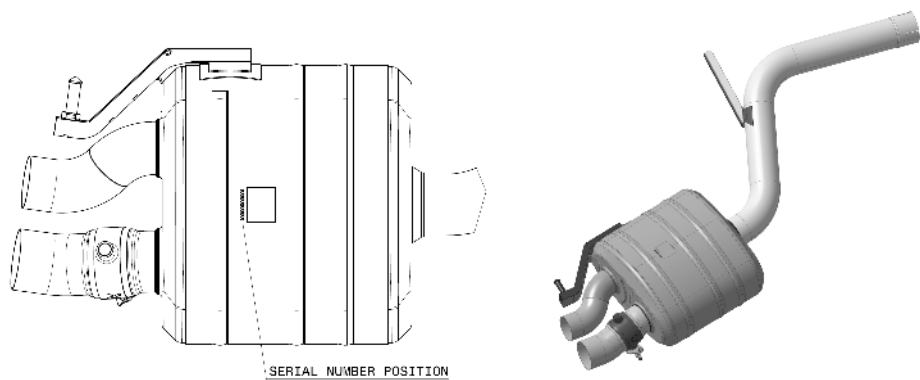

NOISE AND EMISSION WARNINGS

General warning

Because of the world-wide distribution of Akrapovič d.d. products, neither Akrapovič d.d. nor any of its subsidiaries make any representation that the exhaust system complies with the air and/or noise emissions laws, or labeling laws, of any jurisdiction. The purchasers are entirely responsible for informing themselves of the applicable laws where the products are to be used and to comply with those law.

Although legal compliance of Akrapovič products in a specific country should be determined by the user, you can find some basic guidance on compliance of your Akrapovič exhaust system with various legal requirements on the product-related part of our website (please use the QR code on the front page or look for the respective product page on www.akrapovic.com). For EC and ECE type approvals, please refer to the certificate enclosed to your product.

USA WARNING

Various U.S. states and the U.S. federal government have individual laws regulating the use of aftermarket exhaust parts and systems, especially as those parts and systems modify, remove, or replace original equipment catalysts. Please consult the appropriate laws in your area before installing any aftermarket part or system on your vehicle to ensure compliance with all applicable laws. Neither Akrapovic d.d. nor any of their subsidiaries or the sellers of the parts or systems make any representation that any of their parts or systems comply with any such laws.

CALIFORNIA WARNING

California laws prohibit the use of any aftermarket exhaust part or system that modifies, removes or replaces original equipment catalysts unless the California Air Resources Board has issued an Executive Order regarding such part or system or unless the part or system is exempted by being used only on racing vehicles on closed courses. Neither Akrapovic d.d. nor any of their subsidiaries make any representation that any of their parts or systems has received such an Executive Order or that any of their parts or systems conform with the racing vehicles exemption. The purchasers are entirely responsible for informing themselves of applicable California laws and to comply with those laws.

SYMBOLS

The following symbols are used throughout these installation instructions:



TOOLS AND PROTECTIVE EQUIPMENT REQUIRED



TIGHTENING TORQUE



LUBRICATION



HAND TIGHTEN



INSTALLATION TIP



CAUTION OR IMPORTANT

USE BOLT SEALANT



Apply 3 to 4 small drops of bolt sealant onto the cleaned and degreased threads before tightening the bolts.

WARNING! Avoid contact with skin, eyes and mucous membranes. Do not inhale fumes. Keep out of reach of children.

USE ANTI-SEIZE LEAD-FREE COPPER PASTE (black tube)



Provides trouble-free and long-lasting protection against seizing, corrosion and rusting of bolts, threaded ends, nuts, joints, etc. Also protects against vibration, wear and impact. **WARNING! Avoid eye contact. Keep out of reach of children.**

USE ANTI-SEIZING GREASE (white tube)



Prevents seizing, corrosion and excessive wear between the titanium components of your exhaust system. **WARNING! Avoid eye contact. Keep out of reach of children.**

Tools & equipment

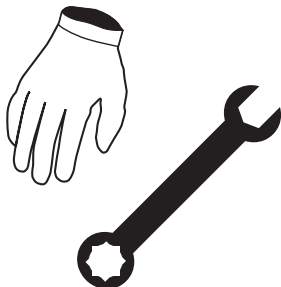

- mechanic gloves
- eye protection
- Torx 40
- Torx 45
- Torx E12
- Socket 16 mm
- T-handle 8 mm wrench
- T-handle 10 mm wrench
- Pry bar
- Ratcheting 10 mm wrench
- Flat screwdriver

PARTS LIST

The following parts should be found in the box:

- Installation Manual
- Homologation certificate/ compliance documents if applicable
- Warranty
- Fitting material
- Muffler and pipes

Detailed list of parts can be found on the Akrapovič website (please use the QR code on the front page or look for "Schematic view" in the respective product page on www.akrapovic.com).

IMPORTANT: The car should be in the off position throughout the dismantling and installation process, as well as any other work done on the exhaust system!

REMOVAL OF STOCK EXHAUST SYSTEM:

The process of uninstalling the original exhaust system may vary depending on the existing exhaust system. Please follow the original exhaust system manufacturer's instructions for uninstalling the original exhaust system.

If you for any reason decide otherwise, please note that any information provided in this respect herein should be considered as general information provided for your convenience only. Akrapovič shall not assume any liability or responsibility with regard to uninstalling your existing exhaust system, warranty coverage of such exhaust system or vehicle or their further fitness for use.

In case your Akrapovič exhaust system may not be used on certain roads or under certain conditions, please keep the stock or other exhaust system that you can use in such circumstances legally.

REMOVAL OF STOCK EXHAUST SYSTEM:

Put the vehicle onto a car lift.

! **CAUTION:** ensure that the car is lifted safely and properly in order to avoid the risk of vehicle damage, injury, or even death!

1. Unscrew the marked nuts and bolts and carefully remove both underfloor panels (F 01).

! **CAUTION:** make sure not to injure yourself or damage any part of the vehicle during this process!



F 01

2. Unscrew the marked bolts and remove the chassis reinforcement (F 02).

! **CAUTION:** make sure not to injure yourself or damage any part of the vehicle during this process!

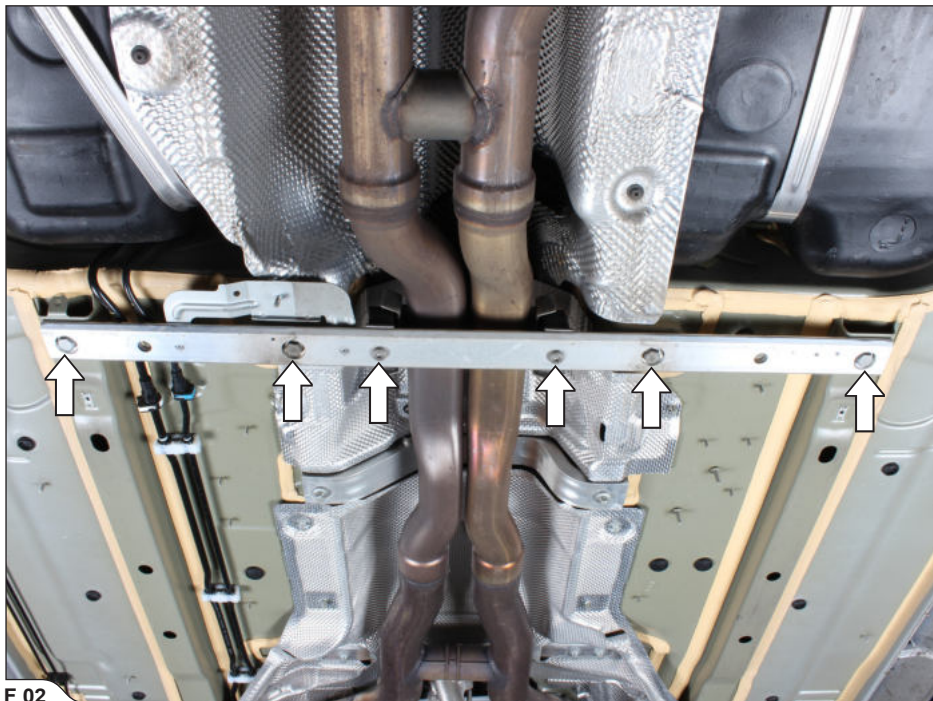

F 02

3. Carefully pull the mufflers' rubber brackets on both mufflers off the pins (**F 03**).
- ! **CAUTION: make sure not to injure yourself or damage any part of the vehicle during this process!**
4. **For vehicles with Performance system only:** disconnect the mufflers' exhaust valve servo motors connectors by the following procedure:
 - Put the Car Key in ON position and car mode in COMFORT (the valves must be closed now)
 - Unplug the connector of the actuators
 - Put the Car-Key in OFF position.

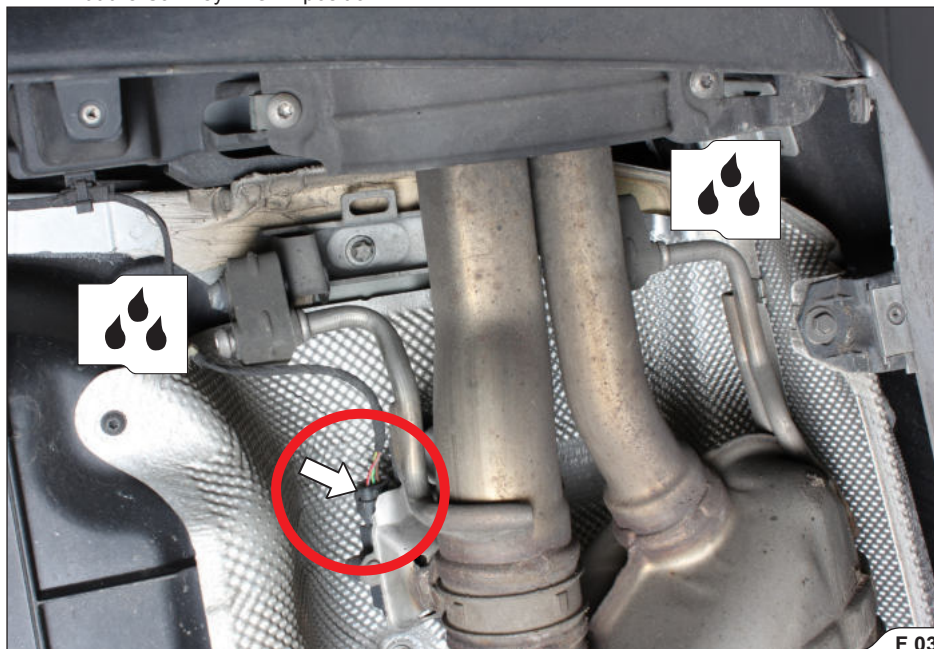

F 03

- Support the mufflers, unscrew the marked clamps and carefully remove the mufflers off the vehicle (F 04).

! **CAUTION:** make sure not to injure yourself or damage any part of the vehicle during this process!

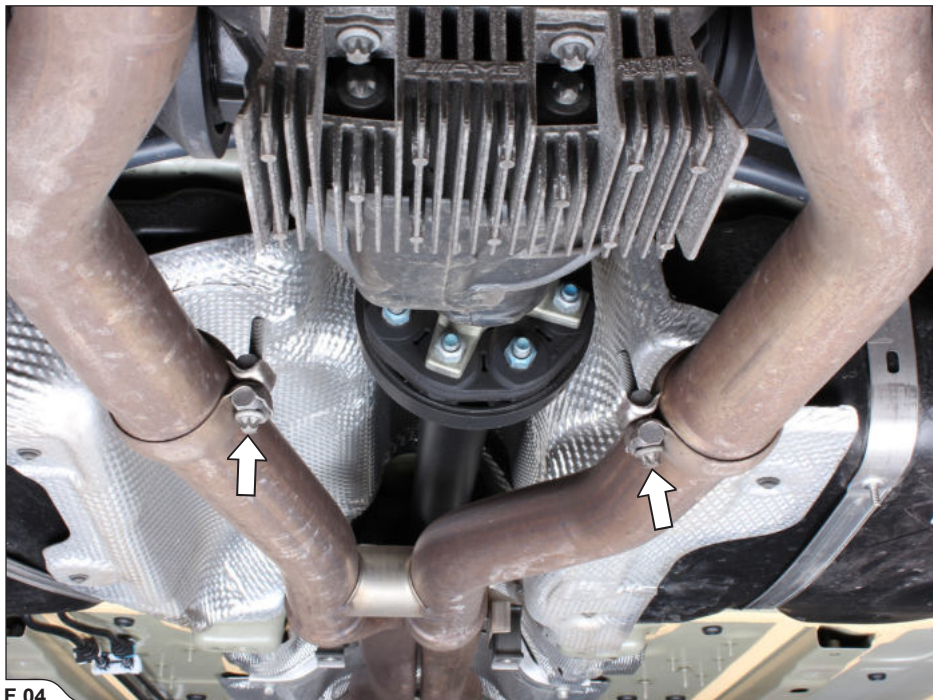

F 04

6. Disconnect the link pipe's exhaust valve servo connector (F 05)

! **IMPORTANT:** make sure, that car key is in OFF position, at least for 2 minutes, before you unplug the connector!

! **IMPORTANT:** do not put the car key in ON position, or start the car, before all connectors are plugged again. Risk of check light on the dashboard!



F 05

7. Support the link pipes, unscrew the marked clamps, unscrew the marked bracket nuts and carefully remove the link pipes off the vehicle (F 06).

! **CAUTION:** make sure not to injure yourself or damage any part of the vehicle during this process!



F 06

8. Unscrew and remove both tail pipes off the bumper (F 07).

! **IMPORTANT:** make sure, not to damage the bumper or tail pipes during this process!



F 07

9. Unscrew the link pipes' servo off the link pipes (**F 08**).

! **IMPORTANT:** make sure not to injure yourself or damage the servo motor during this process!

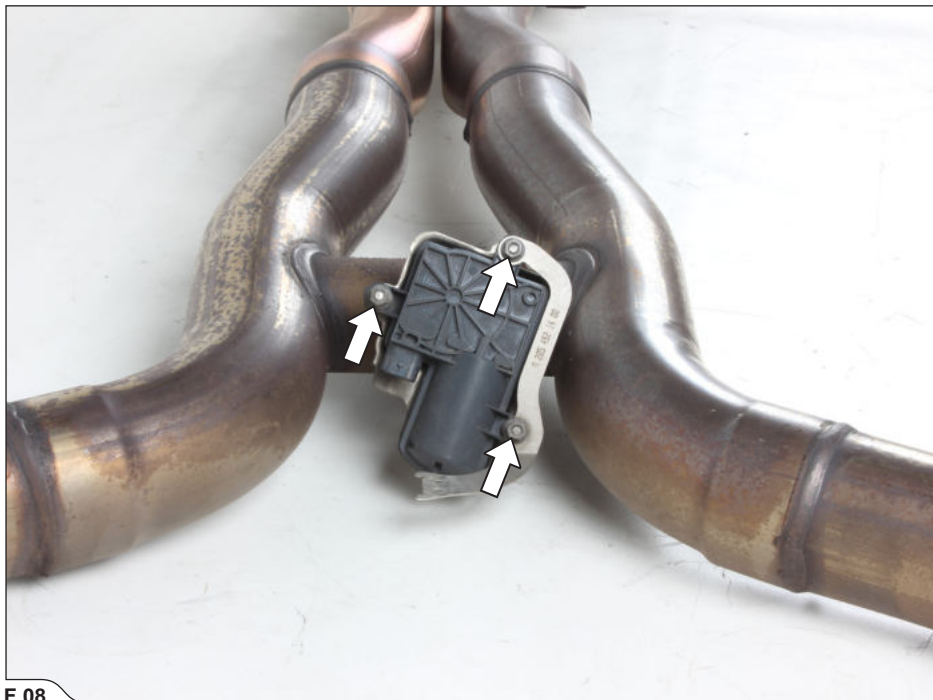

F 08

10. Unscrew the link pipes' rubber brackets (F 09).

! **CAUTION:** make sure not to injure yourself or damage any part of the vehicle during this process!



F 09

INSTALLATION OF THE AKRAPOVIČ EXHAUST SYSTEM:

1. Install the stock rubber brackets onto the Akrapovič link pipes, using stock nuts (**F 10**).
! CAUTION: make sure not to injure yourself or damage the link pipes during this process!



F 10

2. Install the stock chassis reinforcement onto the link pipes, using stock bolts (F 11).

! **CAUTION:** make sure not to injure yourself or damage the link pipes during this process!

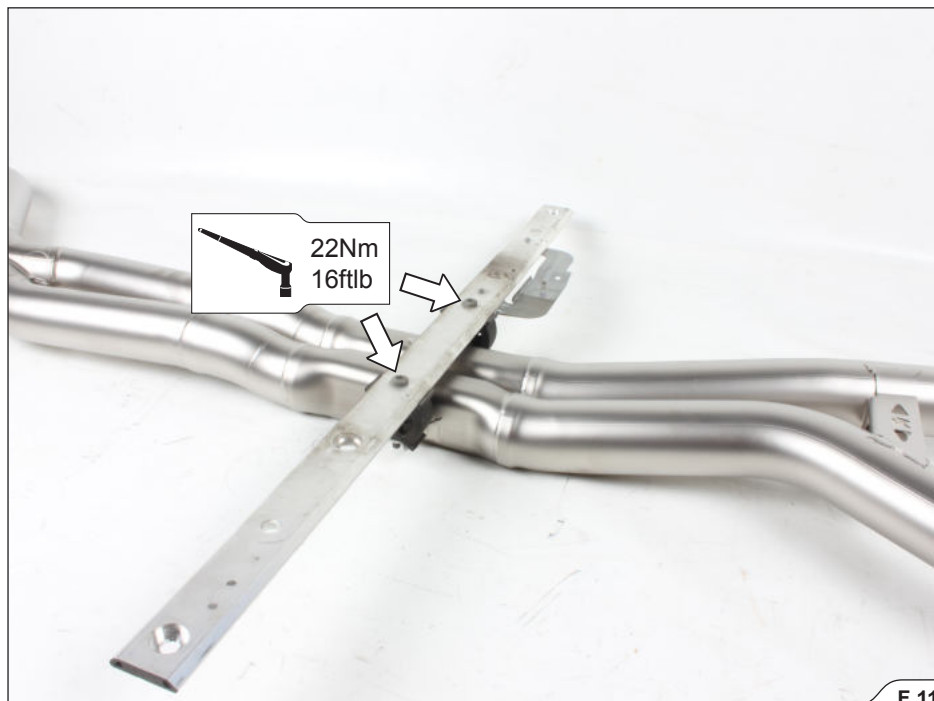

F 11

3. Install the stock exhaust valve actuator onto the link pipes' exhaust valve, using bolts and nuts from Akrapovič installation kit (F 12).

! **CAUTION:** make sure not to injure yourself or damage the valve or actuator during this process!

! **IMPORTANT:** use Akrapovič bolt sealant on the nuts and bolts threads!

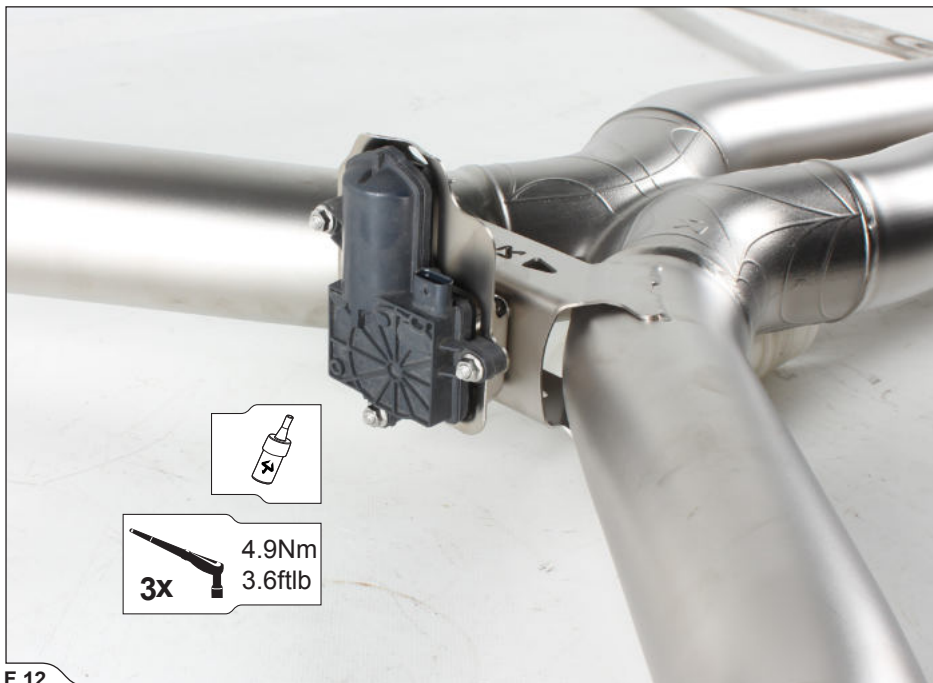

F 12

4. Install the link pipes onto the vehicle, using stock bolts, nuts and clamps (F 13, 14).
- ! **CAUTION:** make sure not to injure yourself or damage the link pipes during this process!

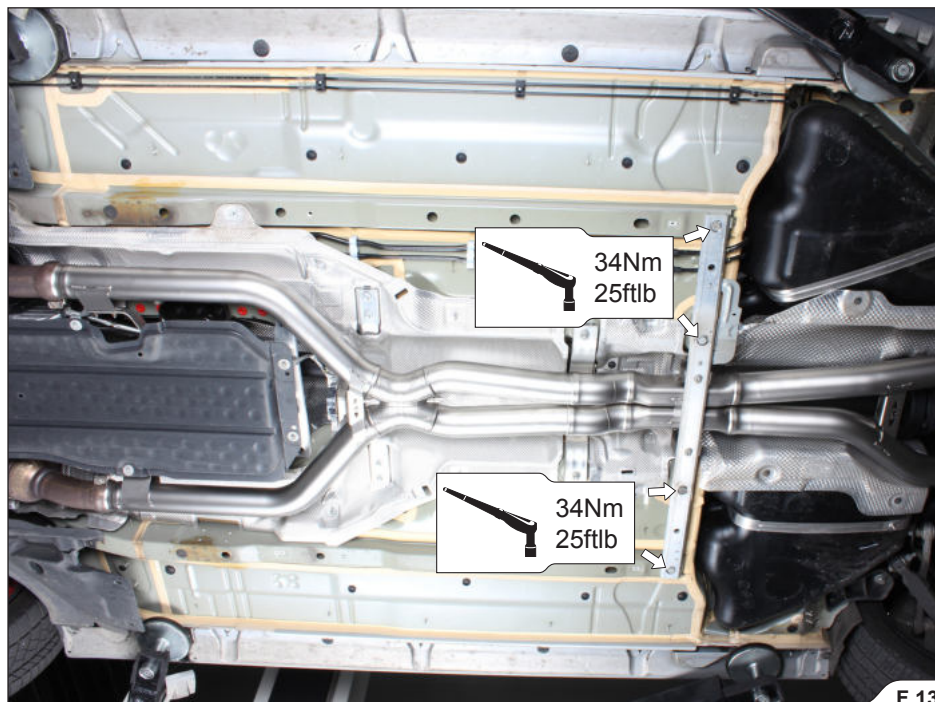

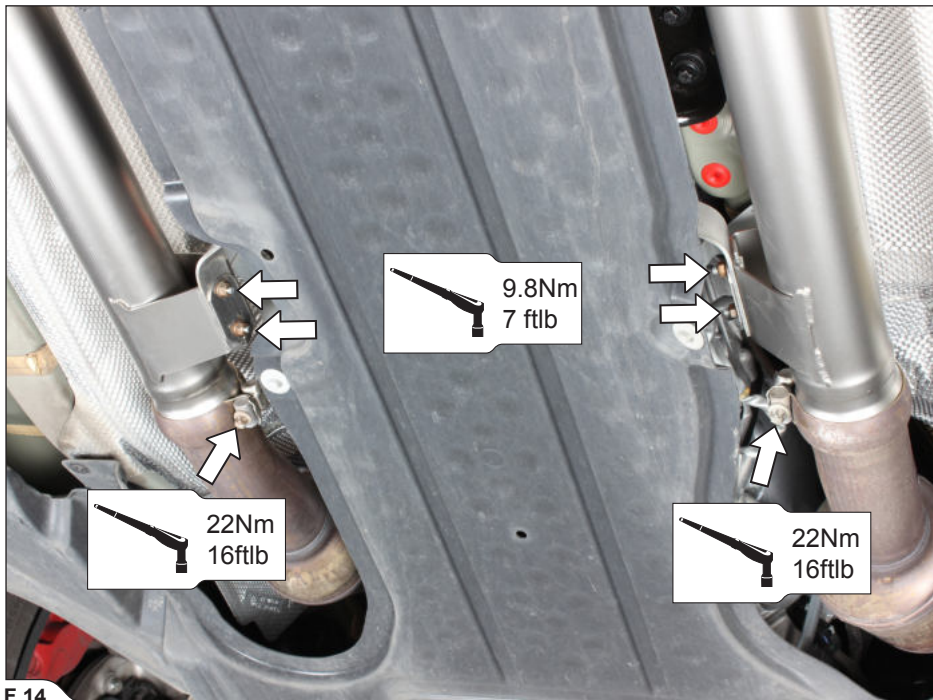

F 14

- Carefully insert the Akrapovič tail pipes into the bumper, center them in respect to rear bumper's cut-outs and tighten them onto the bumper using stock bolts (F 15, 16, 17).

! **CAUTION:** make sure not to injure yourself, damage the tail pipes or any part of the vehicle during this process!

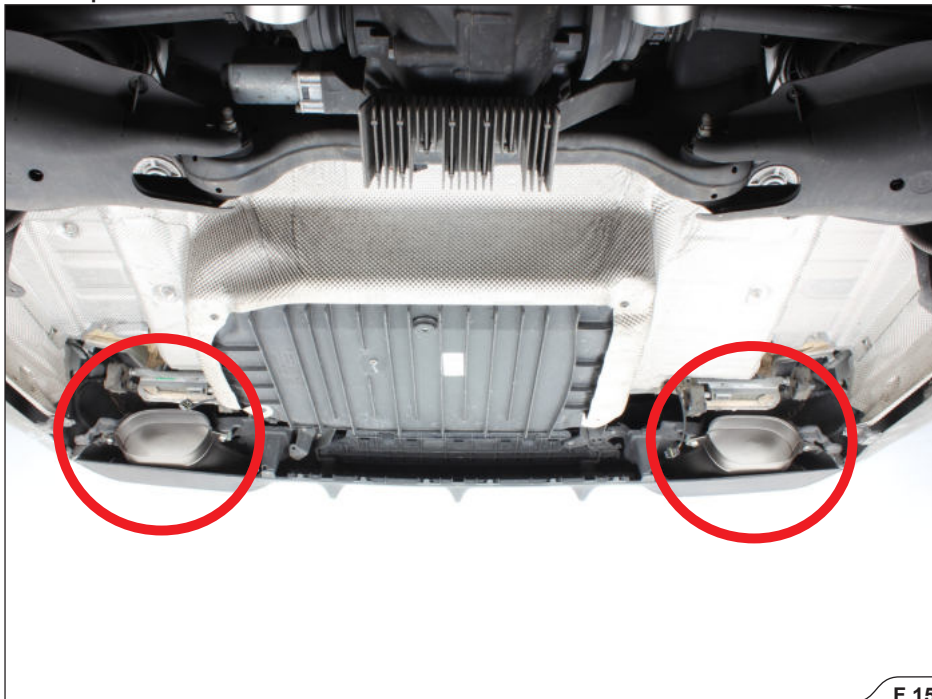



F 16

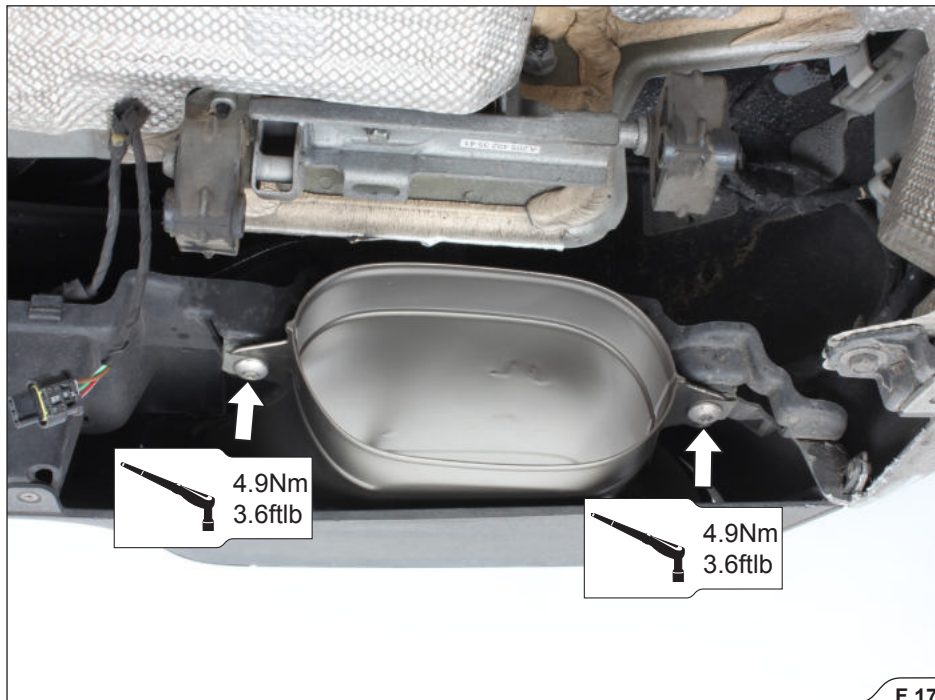

6. Correctly orient and assemble the clamps onto the Akrapovič mufflers' inlets (F 18).

! **IMPORTANT:** hand tighten the clamps only!



F 18

7. **For vehicles with Performance stock system only:** Install the stock exhaust valve actuators onto both mufflers' valves, using bolts and nuts from Akrapovič installation kit (**F 19, 20**).
8. **For vehicles with Base stock system only:** Install the exhaust valve actuators from Akrapovič Valve Actuator Kit onto both mufflers' valves, using bolts and nuts from Akrapovič installation kit (**F 39**).



- ! **CAUTION:** make sure not to injure yourself or damage the valves or actuators during this process!
- ! **IMPORTANT:** use Akrapovič bolt sealant on the nuts and bolts threads!

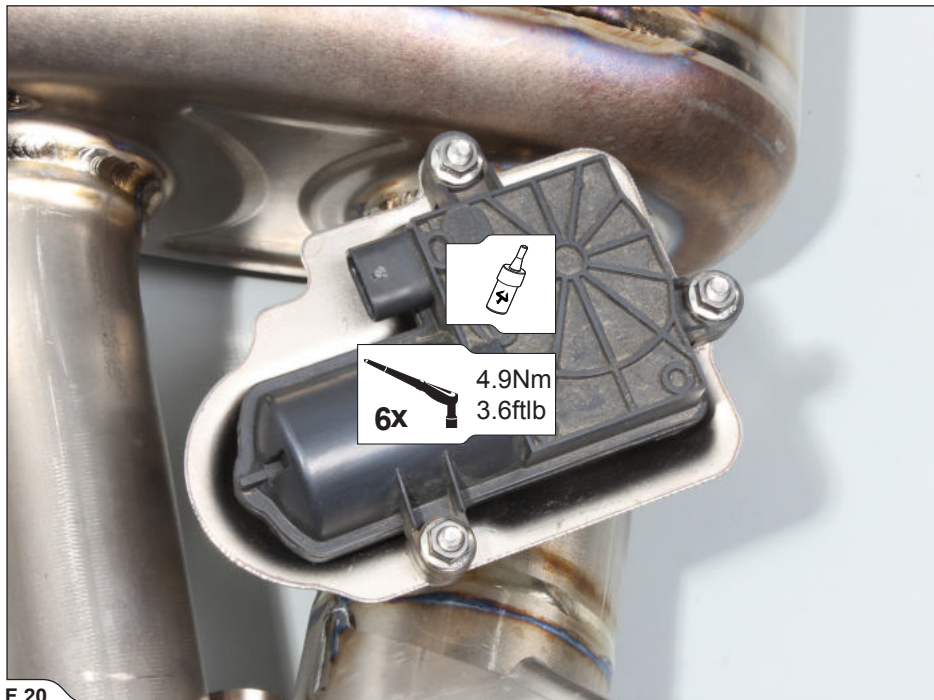

F 20

- Carefully install the mufflers onto the link pipes (put the mufflers' outlets into the tail pipes first, than slide the mufflers' inlet pipes onto the link pipes), attach the mufflers' pins into the rubber brackets and hand tighten the clamps (F 21, 22).

✂ **INSTALLATION TIP:** for easier mounting, lubricate the stock rubber brackets (WD40).

! **IMPORTANT:** hand tighten all the clamps only!

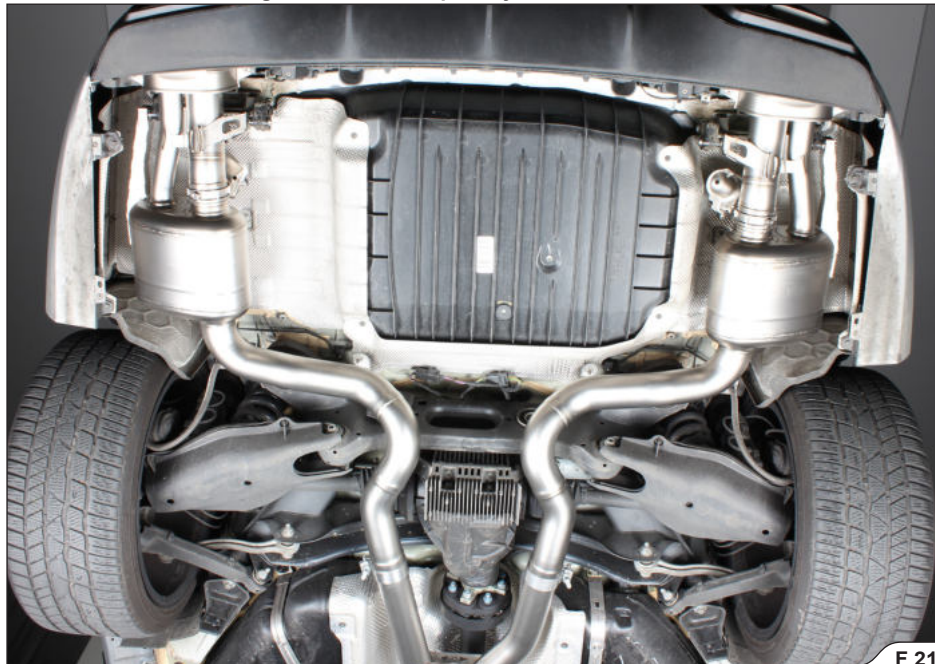

F 21



F 22

- Slide the mufflers all the way onto the link pipes, align the mufflers and tighten the clamps to the specified torque (F 23).

! CAUTION: make sure not to injure yourself or damage any part of the exhaust system during this process!

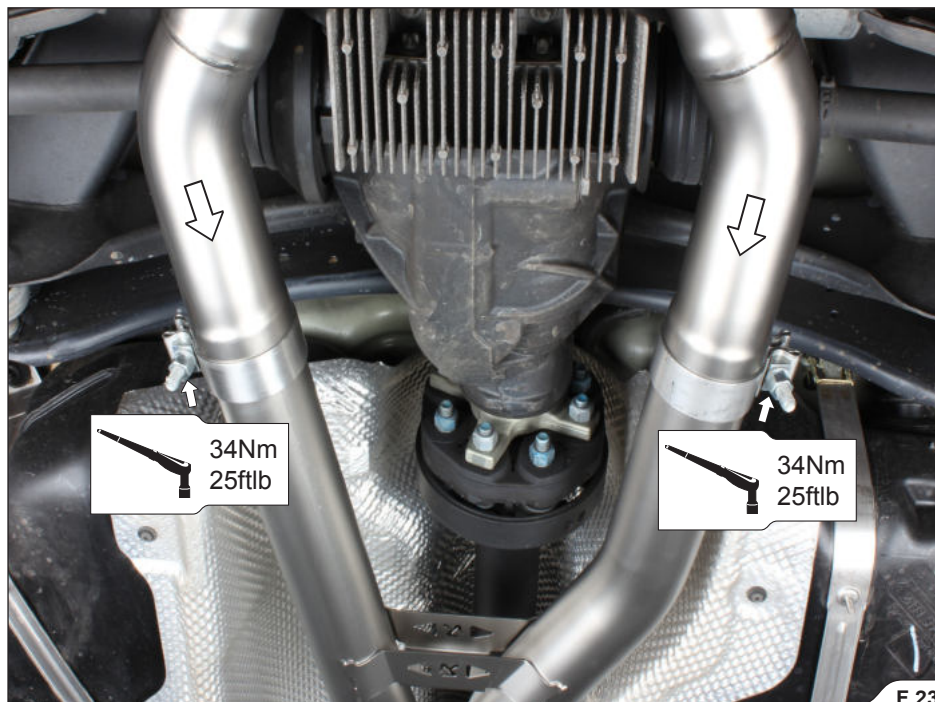

11. **For vehicles with Performance stock system only:** plug the termination connectors onto the stock rear exhaust valve actuators' connectors (F 24).

! **CAUTION:** make sure not to injure yourself or any part of the vehicle during this process!

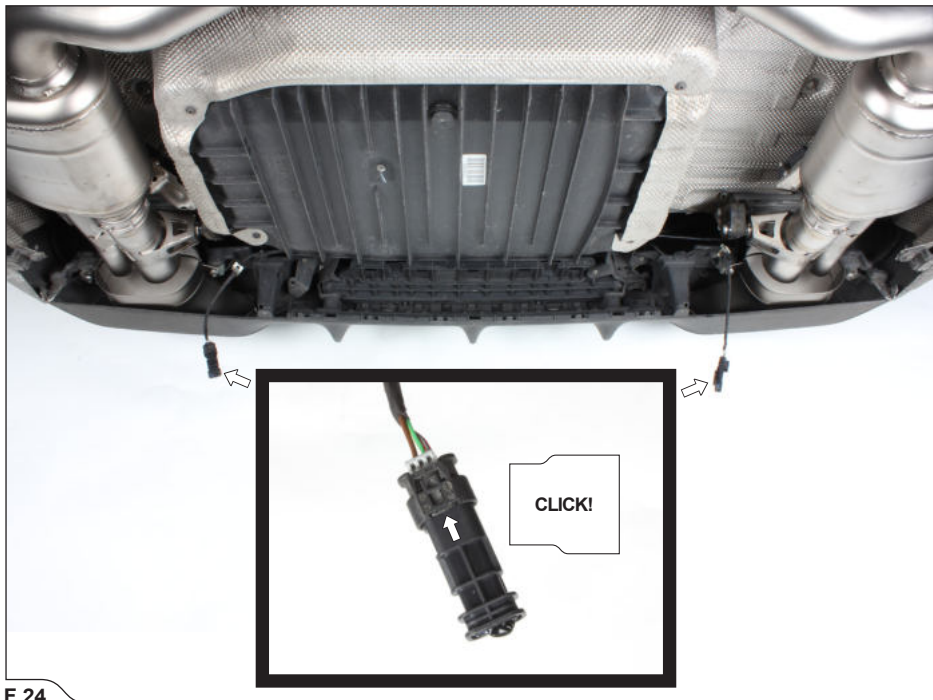

F 24

12. Remove the trunk floor panel to get access to electrical wiring harness in the trunk; check vehicle manufacturer manual for correct trunk panels disassembly (F 25).

! CAUTION: make sure not to injure yourself or damage any part of the vehicle during this process!



F 25

13. Control Kit components (F 26, 27):

1 - Control kit unit

2 - CAN sniffer

3 - To right rear actuator

4 - To left rear actuator

5 - To front (link pipes) actuator

6 - Termination connectors (for Performance stock system only)

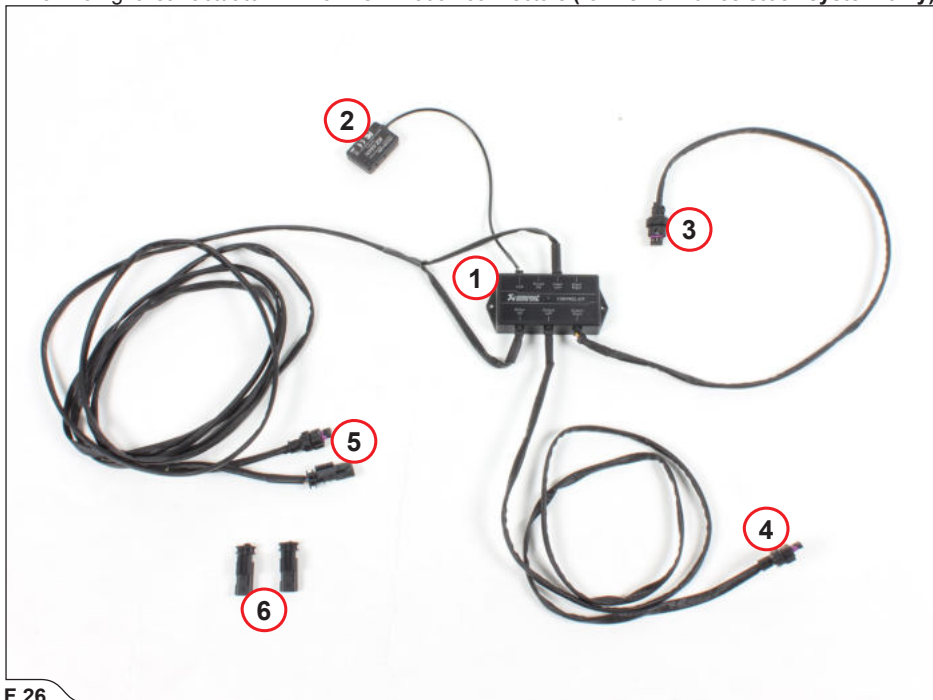

F 26



14. Carefully separate the yellow and yellow-white wires from marked harness, unscrew the CAN sniffer's cover, lead the **yellow** and **yellow/white** wires through the CAN sniffer's wire grooves as shown and reinstall the cover (F 28, 29, 30, 31, 32).

! **IMPORTANT:** Figure 28 - For C63 type W205
Figure 29 - For C63 type S205 and C205

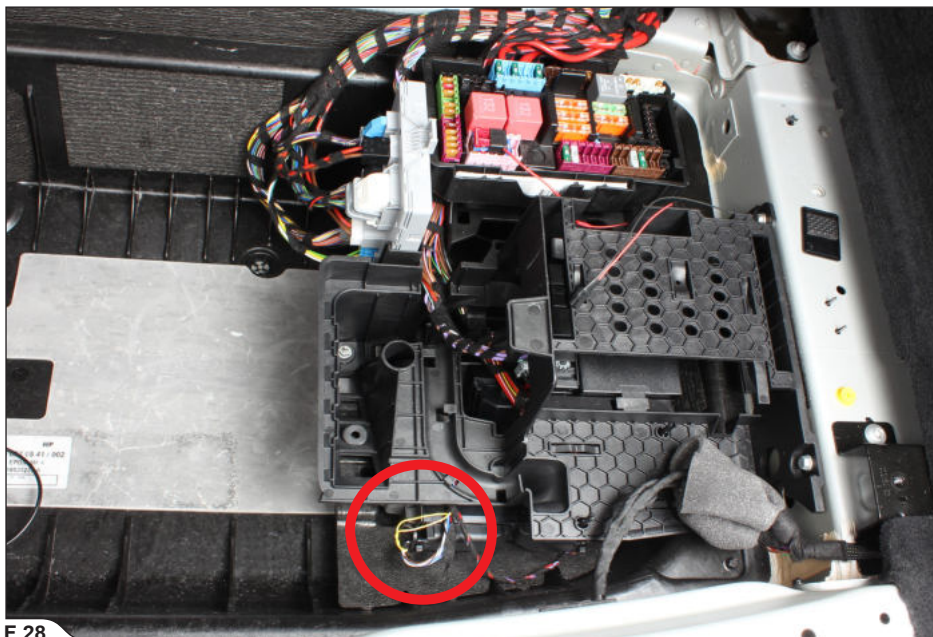

F 28

- ! **IMPORTANT:** in case there are no yellow and yellow-white wires in vehicle's harness, than carefully separate the GREEN (instead of YELLOW) and GREEN-WHITE (instead of YELLOW-WHITE) wires and lead them through the CAN sniffer's wire grooves as shown (F 31, 32).

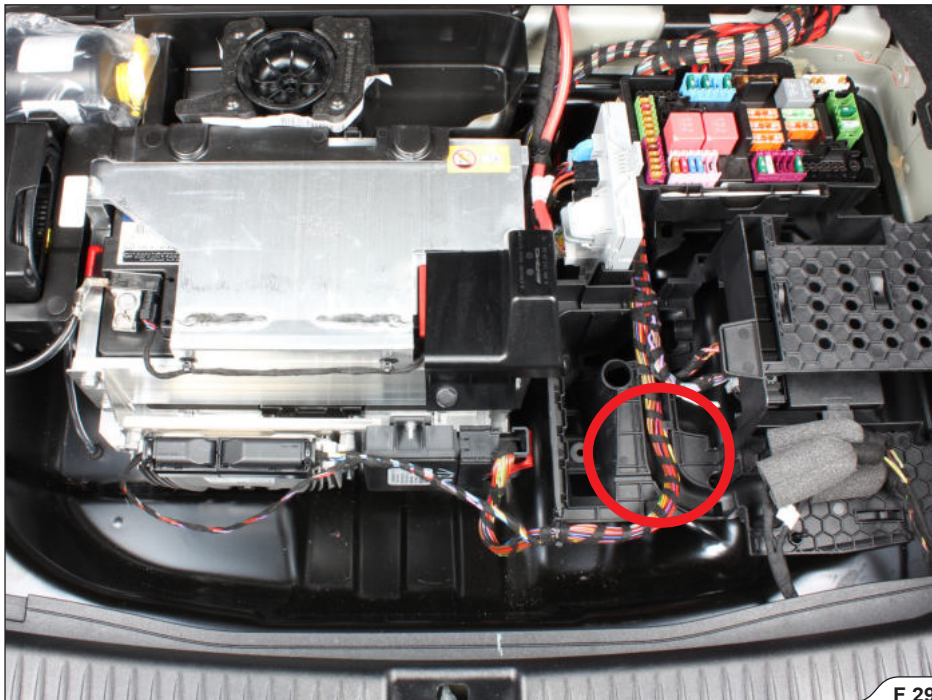

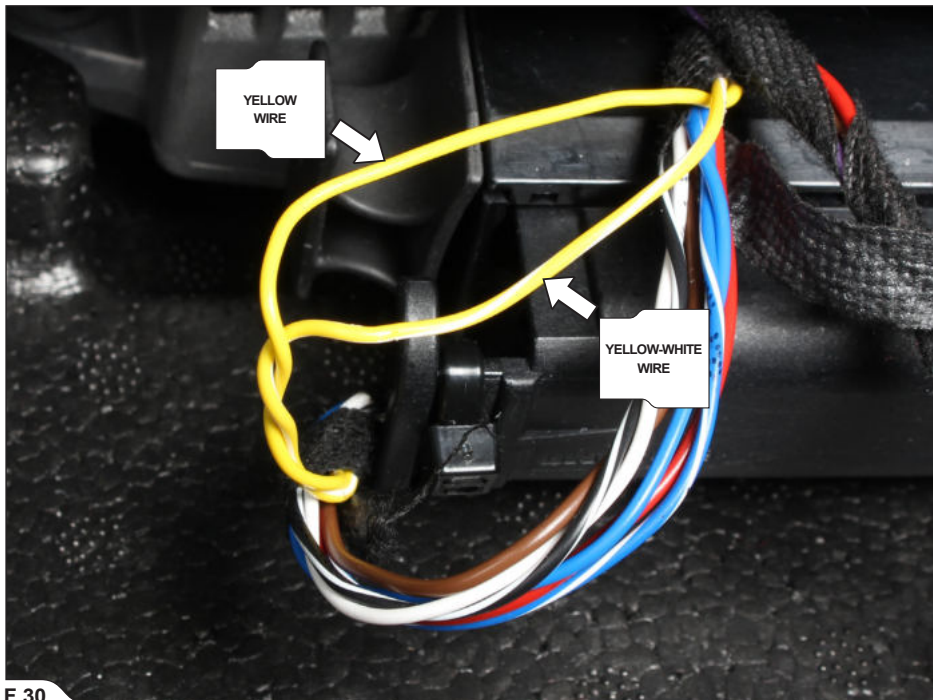

F 30

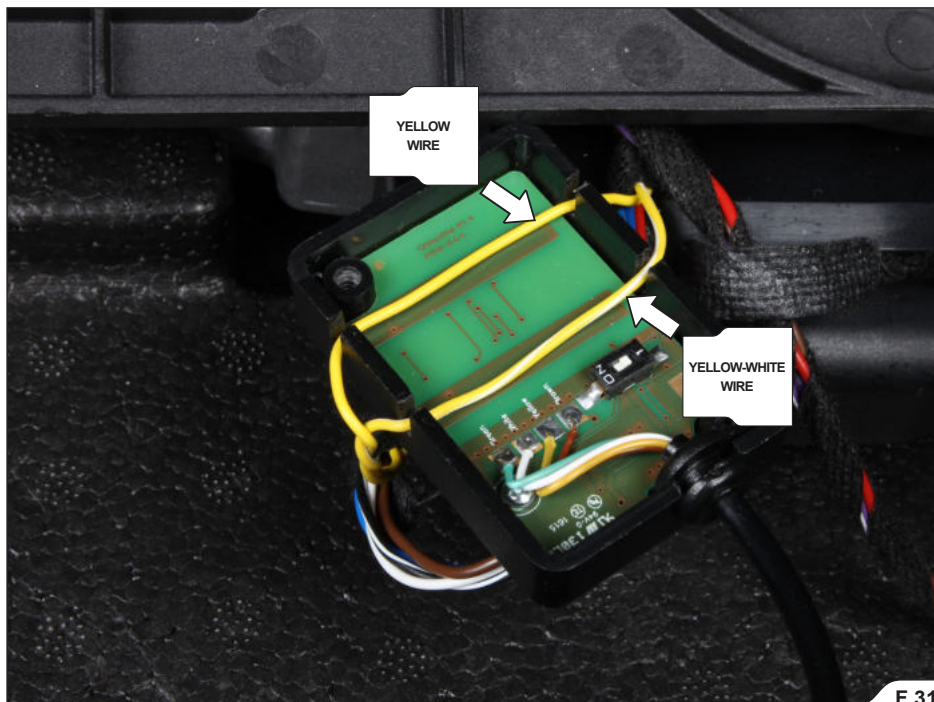



F 32

15. Install the Control Kit components into the trunk as shown; attach the Control Kit unit, using double sided tape, lead the wires through the marked rubber seals to the exhaust valves' actuators and secure them with the tie wraps; connect them to the actuators (F 33, 34, 35, 36, 37, 38, 39, 40, 41, 42, 43, 44, 45, 46).

! **CAUTION:** make sure not to damage the Control Kit or any part of the vehicle during this process!

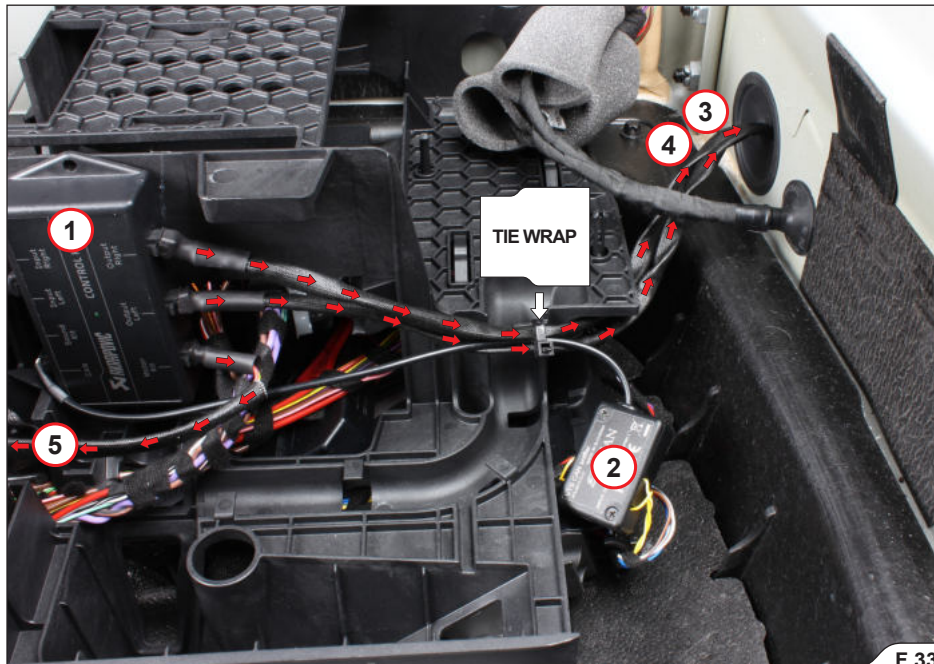

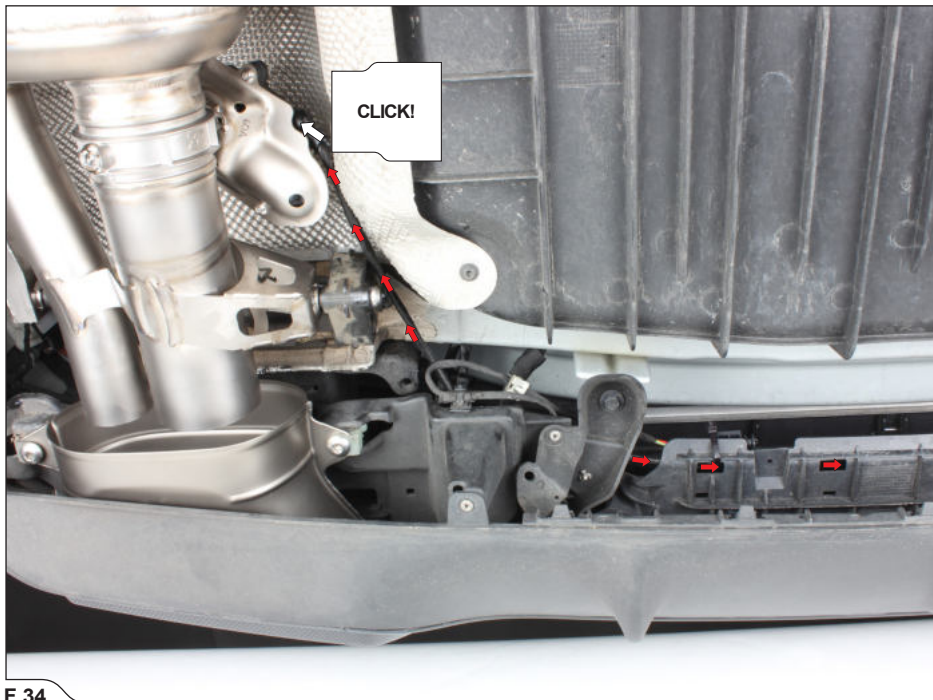

F 34

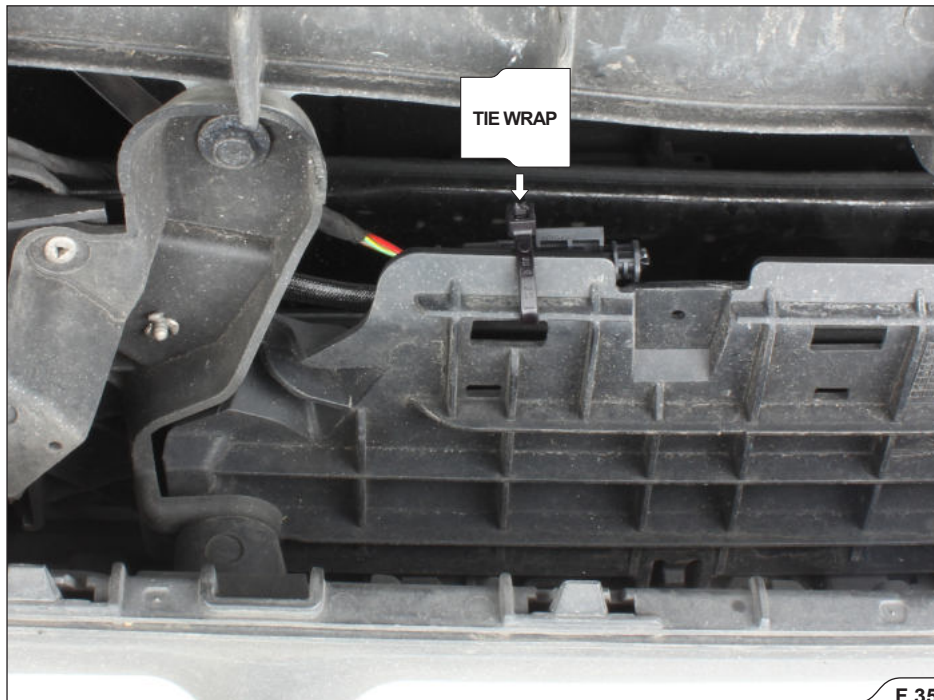

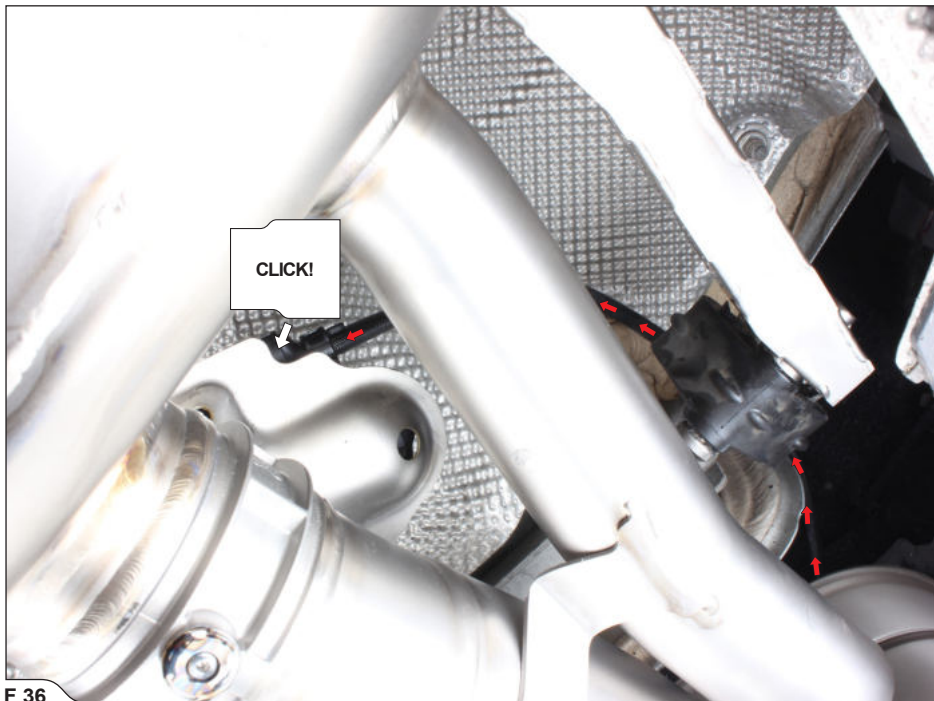

F 36

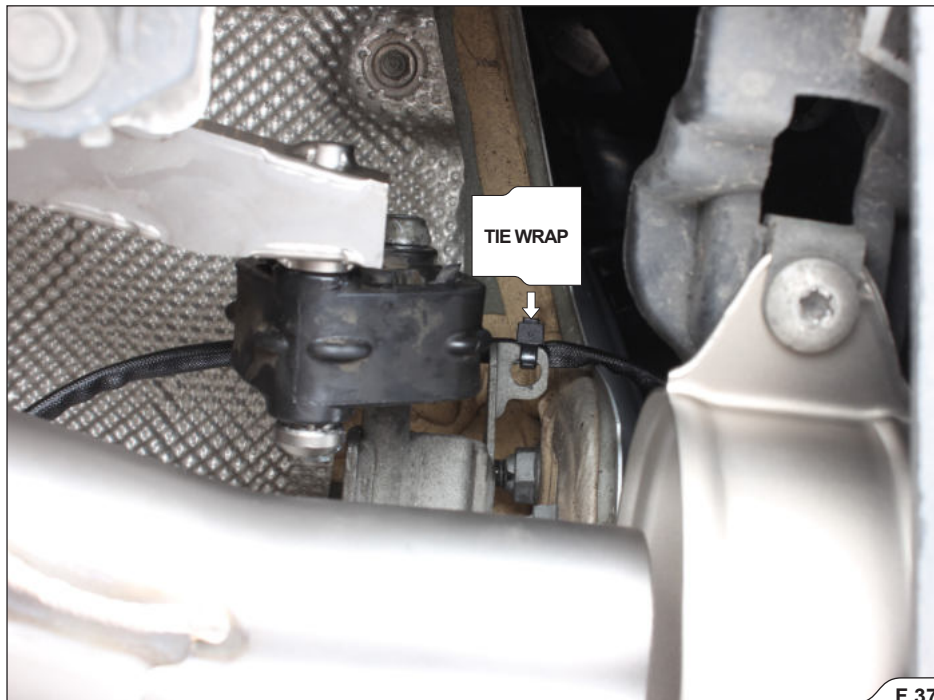



TIE WRAP

A close-up photograph of a vehicle's undercarriage, specifically the area around the rear suspension and rear axle. A white callout box with the text "TIE WRAP" and a downward-pointing arrow indicates a specific location on a metal component, likely a control arm or a bracket, where a tie wrap should be applied. The surrounding area shows various metal parts, bolts, and a multi-colored wire (red, green, blue) protruding from the assembly.

F 38

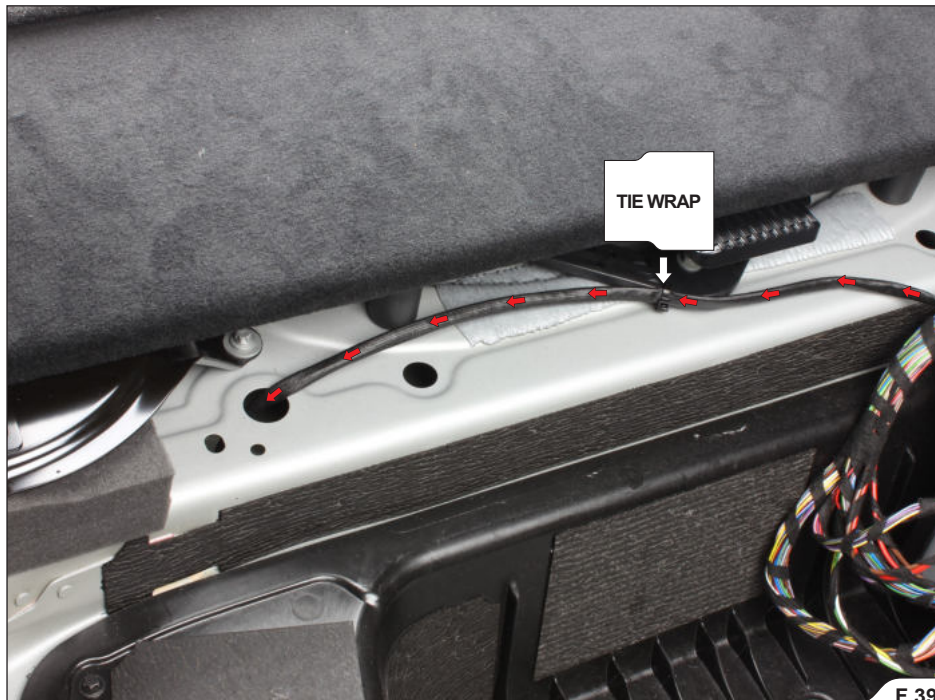



F 40



F 41

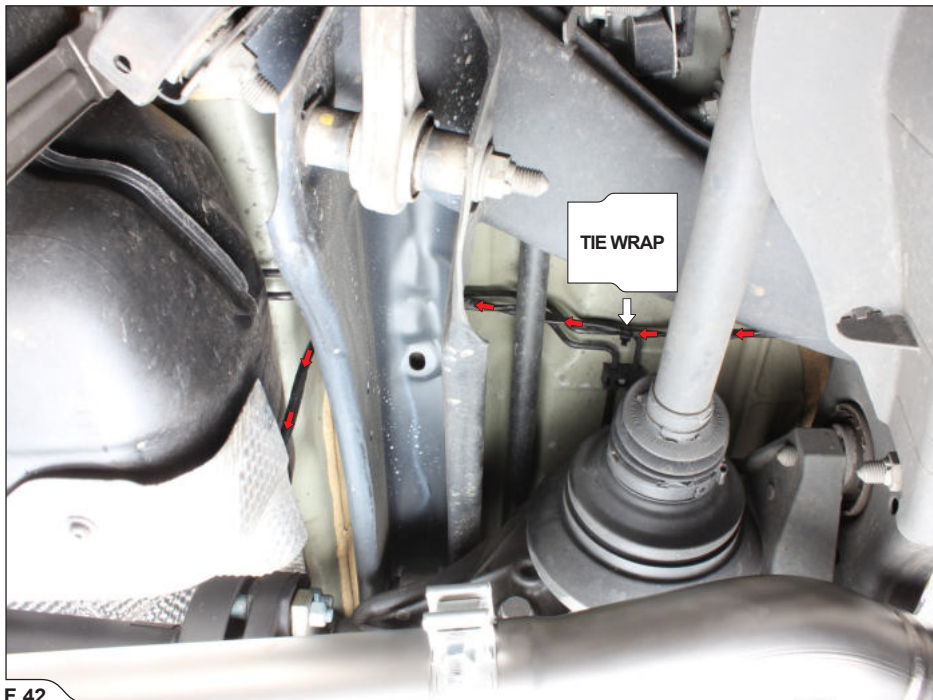

F 42

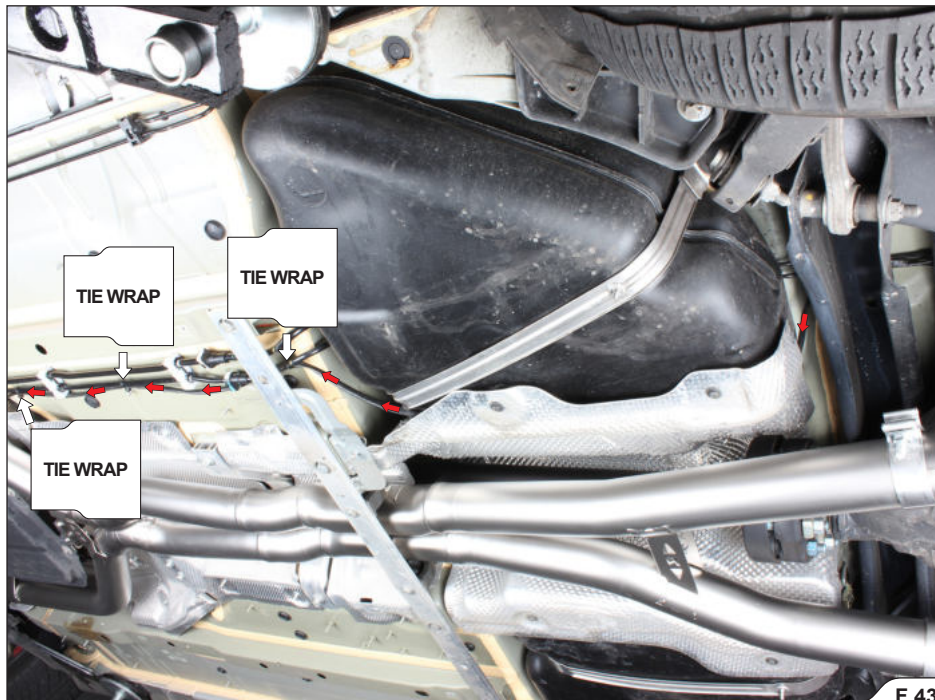

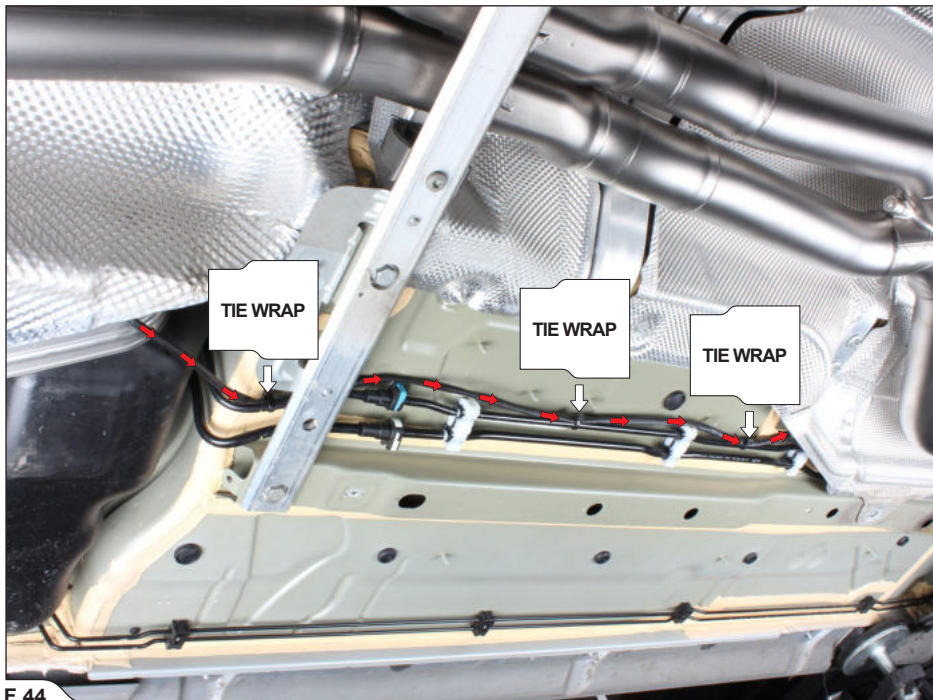

F 44



16. Reinstall all dismantled stock parts; check vehicle manufacturer manual for correct procedures and tightening torques.

! CAUTION: make sure not to injure yourself or damage any part of the exhaust system during this process!

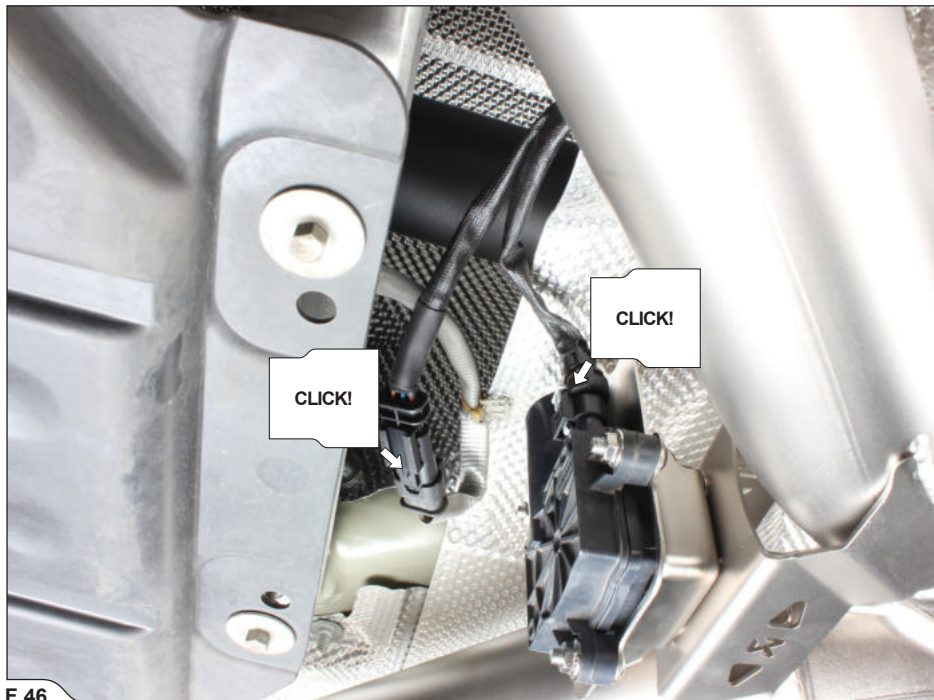

F 46

FINAL INSTALLATION:

- ! **IMPORTANT:** reinstall the dismantled or partially removed stock parts (wheel arches, bumper etc.); check vehicle manufacturer manual for tightening torques.
- ! **IMPORTANT:** make sure all the nuts and bolts are sufficiently tightened. In case the exhaust system touches the cowling or other parts, repeat the adjustment of the exhaust system or contact your authorized dealer.
- ! **IMPORTANT:** clean all exhaust components before the first start of the engine or the stains will burn onto the surfaces!

MAINTENANCE OF THE AKRAPOVIČ EXHAUST SYSTEM:

1. Clean the titanium exhaust components with a multi-purpose spray lubricant (WD-40[®] or equivalent)*, carbon fiber exhaust components with soft and dry cloth and stainless steel components with soft cloth sprayed with contact cleaner, then wipe with soft and dry cloth. A change in the color of the exhaust system is normal due to high temperatures.
2. Periodically make sure all the bolts and springs are sufficiently tight.

*WD-40[®] is a trademark of the WD-40 Company.

 **INSTALLATION TIP: IT IS NORMAL FOR WHITE SMOKE TO COME OUT OF THE MUFFLER AT FIRST OPERATION.**

- ! **CAUTION: DO NOT STAND BEHIND THE MUFFLER AT ANY TIME.**
- ! **CAUTION: DO NOT USE AUTOMOTIVE WHEEL CLEANERS OR ANY CLEANING PRODUCTS WHICH CONTAIN ACIDIC ADDITIVES TO CLEAN THE AKRAPOVIČ EXHAUST SYSTEMS.**

WARNING: THE EXHAUST SYSTEM CAN BE EXTREMELY HOT. ALLOW THE EXHAUST AND ENGINE TO COOL DOWN BEFORE BEGINNING INSTALLATION OR ANY OTHER WORK ON THE EXHAUST SYSTEM. THIS MANUAL IS SPECIFIC TO THE MERCEDES-AMG C63 TYPE W205 / C205. THERE MAY BE SOME DIFFERENCES IN INSTALLATION PROCEDURES FOR OTHER MODELS.

TROUBLESHOOTING:

Problem	Possible cause	Solution
Exhaust gas leaks out of the muffler/pipe clamp connections	loosened clamp	tighten the clamp to specified torque
	connection is not completely joined	tap the connection into place and tighten the clamp to specified torque
Valves are not moving	No supply	Check green LED on the Control Kit. If the LED is off: <ul style="list-style-type: none">• Check electrical connection and connectors
	Error detected	Check green LED on the Control Kit. If the LED is blinking fast: <ul style="list-style-type: none">• Check electrical connections and connectors• Check if the actuators are correctly installed on the valves
Valves are reacting with delay	Incorrect communication sensor installation	Reinstall the communication sensor

DECLARATION OF CONFORMITY OF CONTROL KIT

COMPANY: Akrapovič d.d.
ADDRESS: Malo Hudo 8a
1295 Ivančna Gorica, Slovenia

declares that the following products:

Product name: Control Kit
Trade Name: Akrapovič
Type or model: P-HF886

is in conformity with the requirements of the following Directives of the European Union:
Regulation UN/ECE-R10 rev5



10 R - 05 1139

FCC NOTICE

This device complies with part 15 of the FCC rules. Operation is subject to the following two conditions: **(1)** This device may not cause harmful interference, and **(2)** this device must accept any interference received, including interference that may cause undesired operation.

Changes or modifications not expressly approved by the party responsible for compliance could void the user's authority to operate the equipment.

You can view your product's FCC Declaration of Conformity (DoC) to the FCC 47 CFR Part 15, SubpartB, at <http://www.akrapovic.com/docs/ControlKit/FCCCertification.pdf>.

Industry Canada compliance statement

This Class B digital apparatus complies with Canadian ICES-003. This device complies with Industry Canada licence-exempt RSS standard(s). Operation is subject to the following two conditions:

(1) this device may not cause interference, and **(2)** this device must accept any interference, including interference that may cause undesired operation of the device.

Cet appareil numérique de la classe B est conforme à la norme NMB-003 du Canada. Le présent appareil est conforme aux CNR d'Industrie Canada applicables aux appareils radio exempts de licence. L'exploitation est autorisée aux deux conditions suivantes :

(1) l'appareil ne doit pas produire de brouillage, et **(2)** l'utilisateur de l'appareil doit accepter tout brouillage radioélectrique subi, même si le brouillage est susceptible d'en compromettre le fonctionnement.

European Union Directives Conformance Statement



Akrapovič d.d. hereby declares that this Akrapovič Control Kit P-HF886 is in compliance with the essential requirements and other relevant provisions of Directive 2004/108/EU

You can view your product's Declaration of Conformity (DoC) to Directive 2004/108/EU (to EMC Directive) at <http://www.akrapovic.com/docs/ControlKit/CECertification.pdf>.

DECLARATION OF CONFORMITY OF CAN SNIFFER

COMPANY: Atlan d.o.o.
ADDRESS: Sveti Anton, Hrib 9
6276 Pobegi, Slovenia

declares that the following products:

Product name: Communication Detector
Trade Name: Atlan
Type or model: VTS CAN SNIFFER

is in conformity with the requirements of the following Directives of the European Union:
Regulation UN/ECE-R10 rev5



10 R - 05 1141

FCC NOTICE

This device complies with part 15 of the FCC rules. Operation is subject to the following two conditions: **(1)** This device may not cause harmful interference, and **(2)** this device must accept any interference received, including interference that may cause undesired operation.

Changes or modifications not expressly approved by the party responsible for compliance could void the user's authority to operate the equipment.

You can view your product's FCC Declaration of Conformity (DoC) to the FCC 47 CFR Part 15, SubpartB, at <http://www.akrapovic.com/docs/CanSniffer/FCCCertification.pdf>.

Industry Canada compliance statement

This Class B digital apparatus complies with Canadian ICES-003. This device complies with Industry Canada licence-exempt RSS standard(s). Operation is subject to the following two conditions:

(1) this device may not cause interference, and **(2)** this device must accept any interference, including interference that may cause undesired operation of the device.

Cet appareil numérique de la classe B est conforme à la norme NMB-003 du Canada. Le présent appareil est conforme aux CNR d'Industrie Canada applicables aux appareils radio exempts de licence. L'exploitation est autorisée aux deux conditions suivantes :

(1) l'appareil ne doit pas produire de brouillage, et **(2)** l'utilisateur de l'appareil doit accepter tout brouillage radioélectrique subi, même si le brouillage est susceptible d'en compromettre le fonctionnement.

European Union Directives Conformance Statement

CE Atlán d.o.o. hereby declares that this Atlán Communication Detector VTS CAN SNIFFER is in compliance with the essential requirements and other relevant provisions of Directive 2004/108/EU

You can view your product's Declaration of Conformity (DoC) to Directive 2004/108/EU (to EMC Directive) at <http://www.akrapovic.com/docs/CanSniffer/CECertification.pdf>.

www.akrapovic.com

